

Nobuko Yoshida

Imperial College London

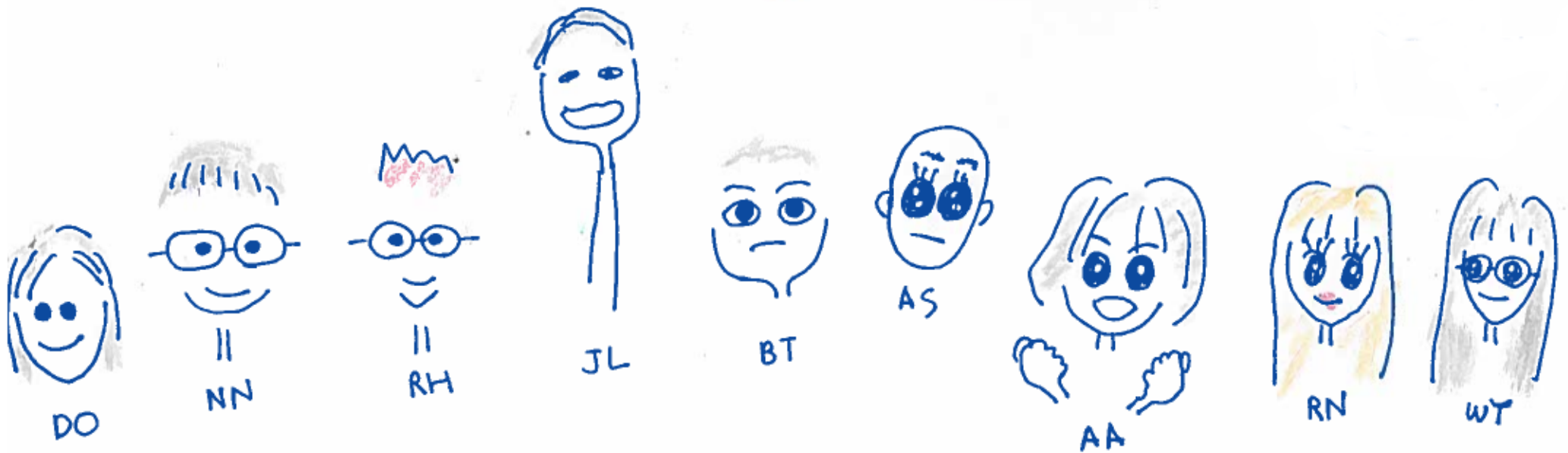

Mobility Reading Group

mrg.doc.ic.ac.uk

Selected Publications 2015/2016



- **[CC'16]** Nicholas Ng, NY: Static Deadlock Detection for Concurrent Go by Global Session Graph Synthesis.
- **[FASE'16]** Raymond Hu, NY: Hybrid Session Verification through Endpoint API Generation.
- **[TACAS'16]** Julien Lange, NY: Characteristic Formulae for Session Types.
- **[ESOP'16]** Dimitrios Kouzapas, Jorge A. Pérez, NY: On the Relative Expressiveness of Higher-Order Session Processes.
- **[POPL'16]** Dominic Orchard, NY: Effects as sessions, sessions as effects .
- **[FSTTCS'15]** Romain Demangeon, NY: On the Expressiveness of Multiparty Session Types.
- **[OOPSLA'15]** Hugo A. López, Eduardo R. B. Marques, Francisco Martins, Nicholas Ng, César Santos, Vasco Thudichum Vasconcelos, NY: Protocol-Based Verification of Message-Passing Parallel Programs .
- **[CONCUR'15]** Dimitrios Kouzapas, Jorge A. Pérez, NY: Characteristic Bisimulations for Higher-Order Session Processes .
- **[CONCUR'15]** Laura Bocchi, Julien Lange, NY: Meeting Deadlines Together.
- **[CONCUR'15]** Marco Carbone, Fabrizio Montesi, Carsten Schürmann, NY: Multiparty Session Types as Coherence Proofs.
- **[CC'15]** Nicholas Ng, Jose G.F. Coutinho, NY: Protocols by Default: Safe MPI Code Generation based on Session Types.
- **[PPoPP'15]** Tiago Cogumbreiro, Raymond Hu, Francisco Martins, NY: Dynamic deadlock verification for general barrier synchronisation.
- **[POPL'15]** Julien Lange, Emilio Tuosto, NY: From communicating machines to graphical choreographies.

Selected Publications 2015/2016



- **[CC'16]** Nicholas Ng, NY: Static Deadlock Detection for Concurrent Go by Global Session Graph Synthesis.
- **[FASE'16]** Raymond Hu, NY: Hybrid Session Verification through Endpoint API Generation.
- **[TACAS'16]** Julien Lange, NY: Characteristic Formulae for Session Types.
- **[ESOP'16]** Dimitrios Kouzapas, Jorge A. Pérez, NY: On the Relative Expressiveness of Higher-Order Session Processes.
- **[POPL'16]** Dominic Orchard, NY: Effects as sessions, sessions as effects .
- **[FSTTCS'15]** Romain Demangeon, NY: On the Expressiveness of Multiparty Session Types.
- **[OOPSLA'15]** Hugo A. López, Eduardo R. B. Marques, Francisco Martins, Nicholas Ng, César Santos, Vasco Thudichum Vasconcelos, NY: Protocol-Based Verification of Message-Passing Parallel Programs .
- **[CONCUR'15]** Dimitrios Kouzapas, Jorge A. Pérez, NY: Characteristic Bisimulations for Higher-Order Session Processes .
- **[CONCUR'15]** Laura Bocchi, Julien Lange, Nobuko Yoshida: Meeting Deadlines Together.
- **[CONCUR'15]** Marco Carbone, Fabrizio Montesi, Carsten Schürmann, NY: Multiparty Session Types as Coherence Proofs.
- **[CC'15]** Nicholas Ng, Jose G.F. Coutinho, NY: Protocols by Default: Safe MPI Code Generation based on Session Types.
- **[PPoPP'15]** Tiago Cogumbreiro, Raymond Hu, Francisco Martins, NY: Dynamic deadlock verification for general barrier synchronisation.
- **[POPL'15]** Julien Lange, Emilio Tuosto, NY: From communicating machines to graphical choreographies.

<http://scribble.doc.ic.ac.uk:55000/>



```
1 module examples;
2
3 global protocol HelloWorld(role Me, role World) {
4     hello() from Me to World;
5     choice at World {
6         goodMorning() from World to Me;
7     } or {
8         goodAfternoon() from World to Me;
9     }
10 }
11
```

Hello World ▾

Check

Protocol:

Role:

Project

Generate Graph

Applications

OOI Governance

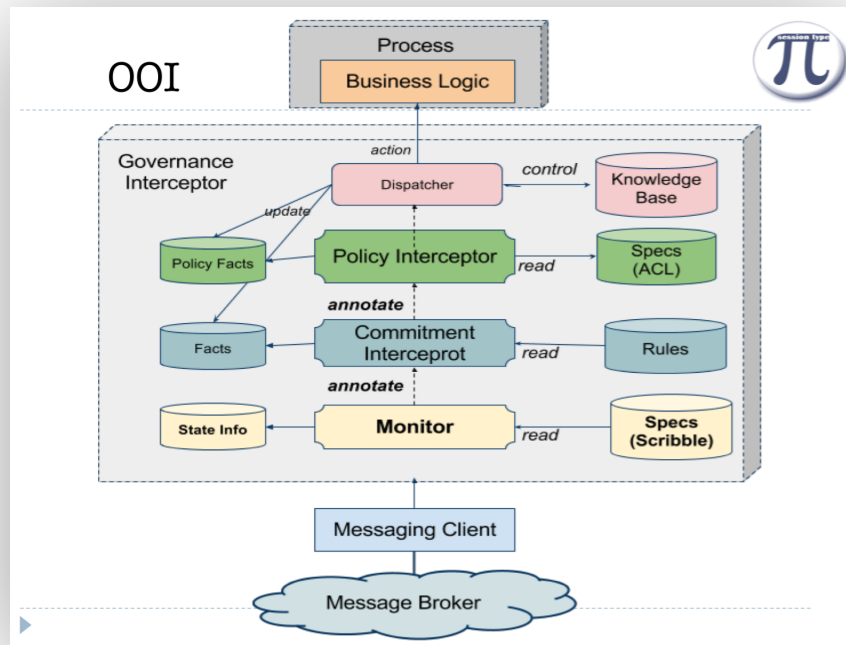

ZDLC: Process Modeling

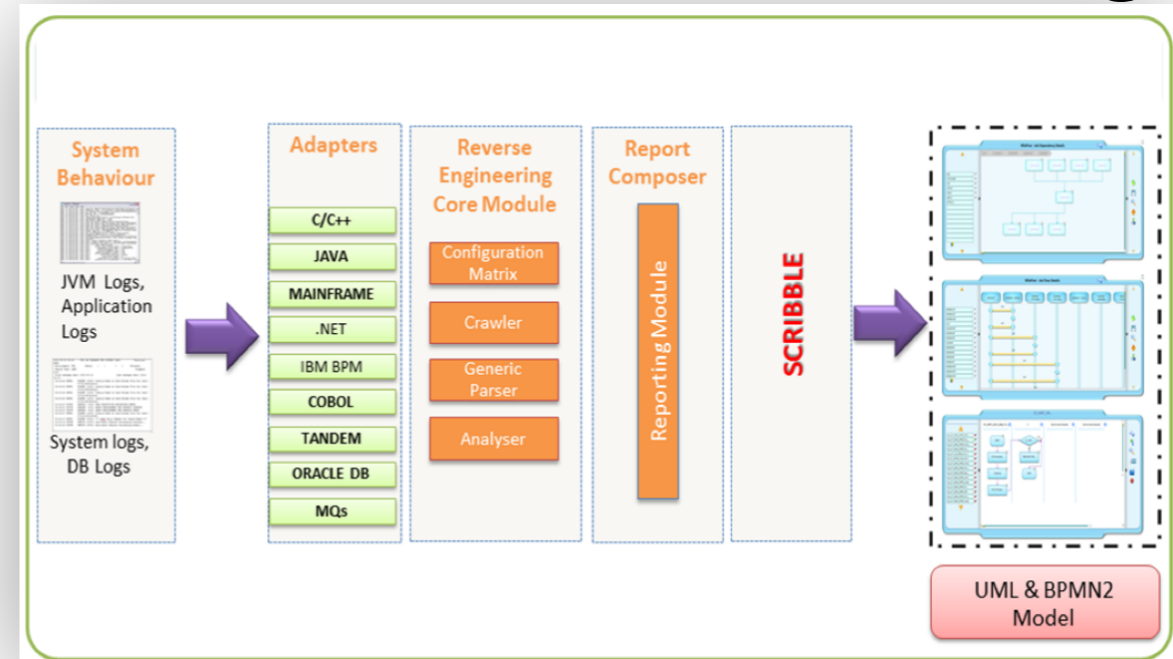

Protocol Verification

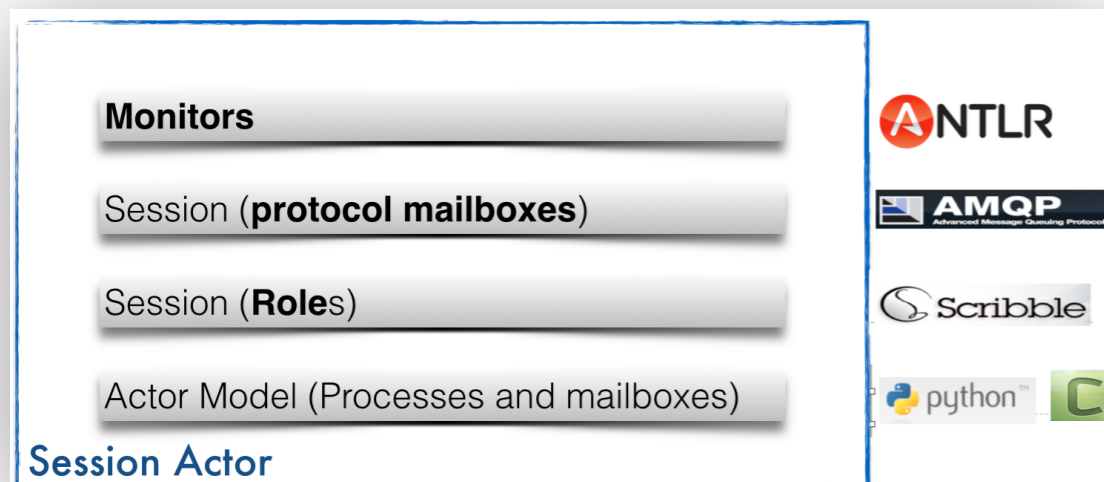

MPI code generations

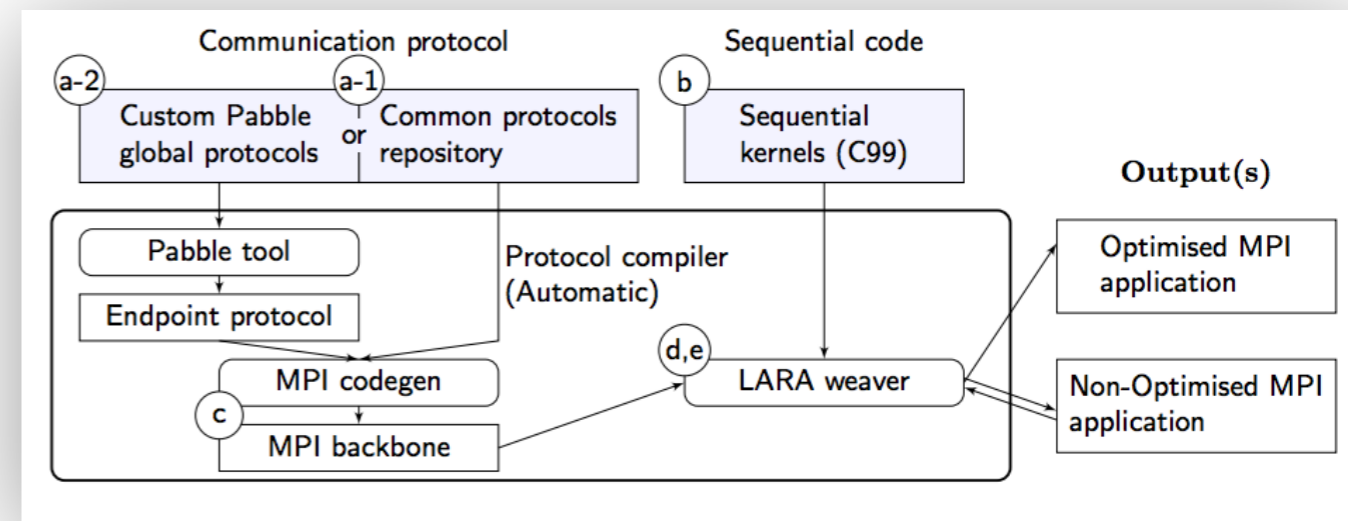

Dynamic Monitoring

[RV'13, COORDINATION'14, FMSSD'15]

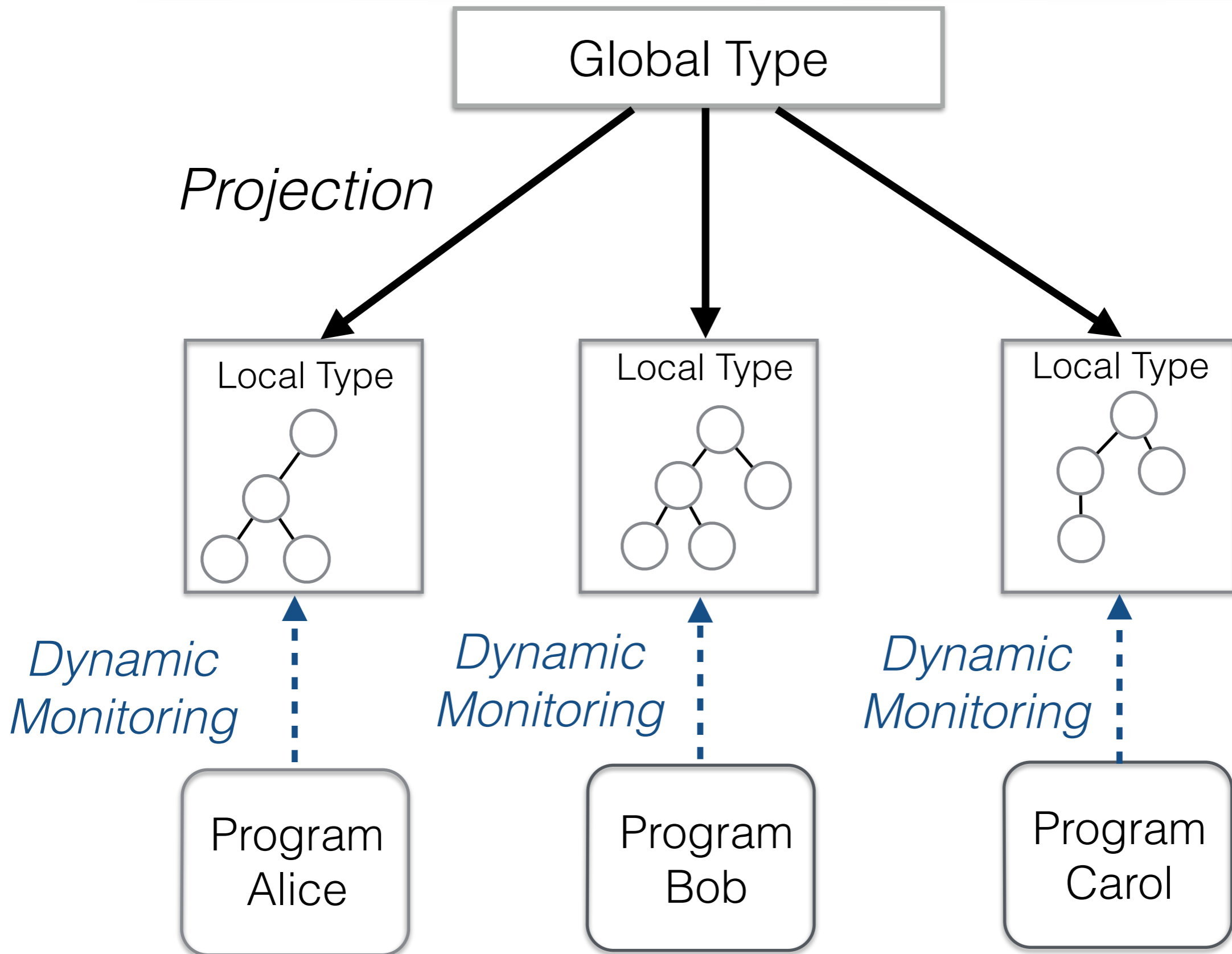

Type Checking [OOPSLA'15, POPL'16]

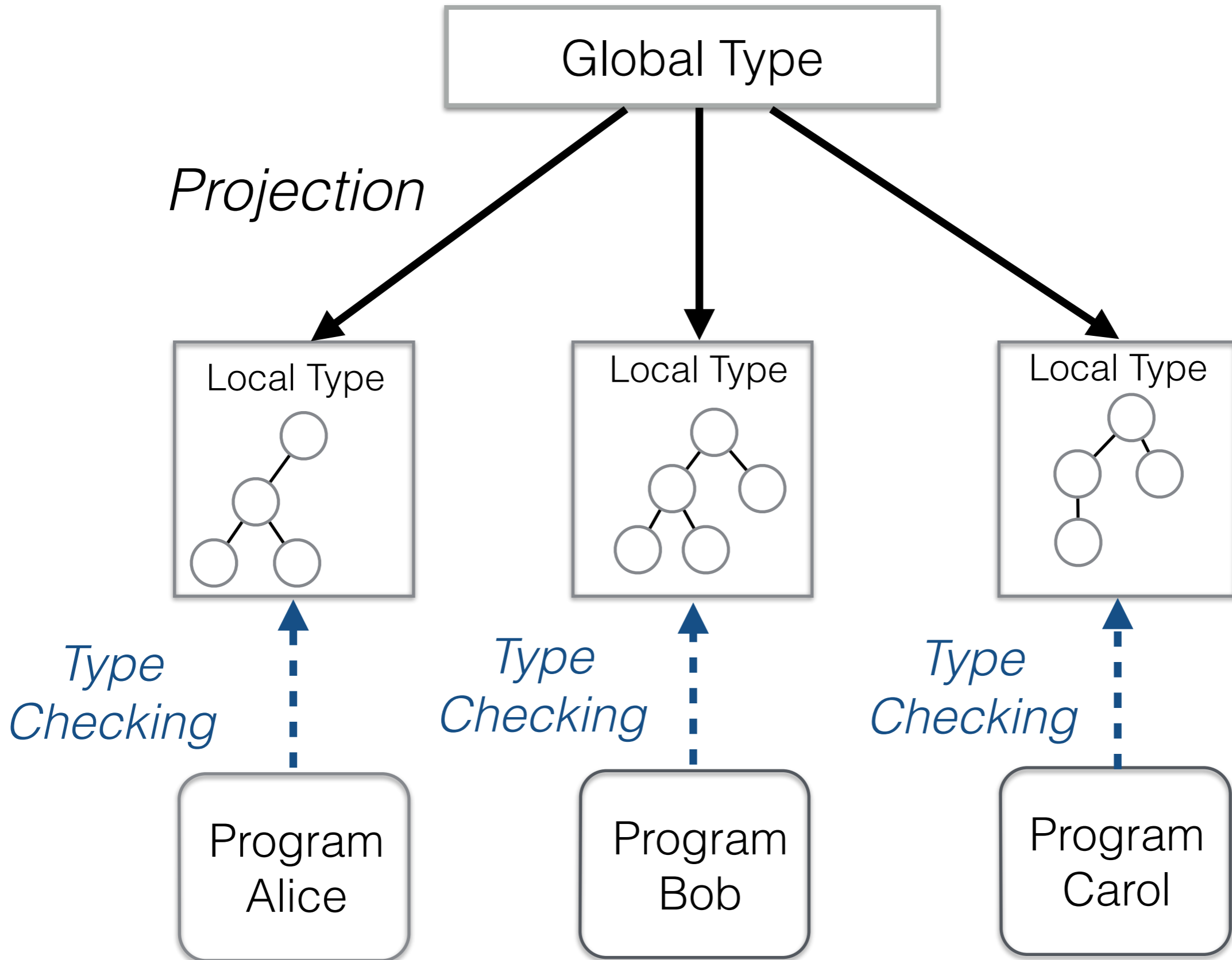

Code Generation [CC'15, FASE'16]

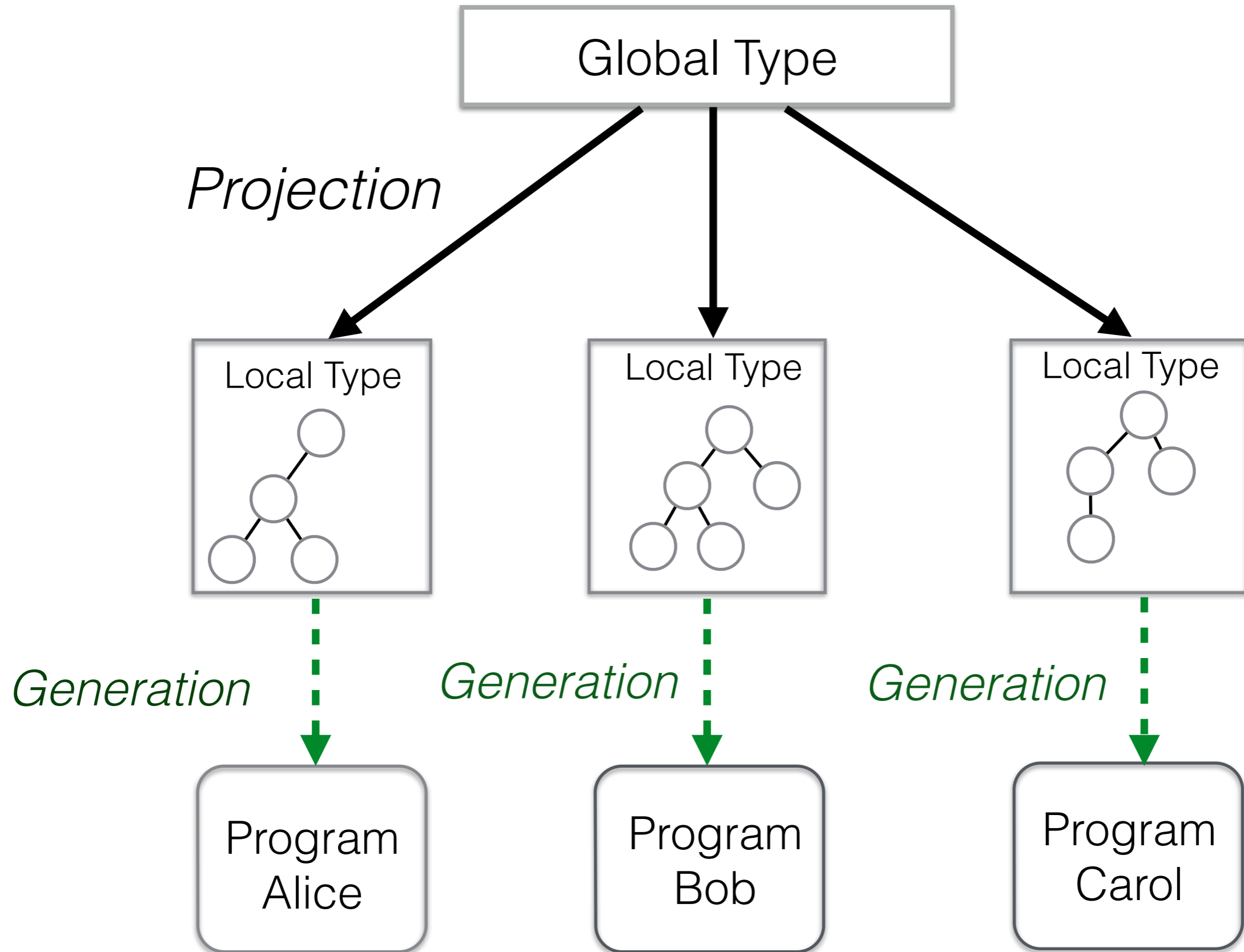

Synthesis

[ICALP'13, POPL'15, CONCUR'15, TACAS'16, CC'16]

