

# Multiparty Session Types and their Applications



<http://mrg.doc.ic.ac.uk/>

Nobuko Yoshida

Imperial College London

University of Pennsylvania

19th May, 2016

# The Kohei Honda Prize for Distributed Systems Queen Mary, University of London

Posted with permission from QMUL on 17<sup>th</sup> Dec 2013. [Original article](#) written by Edmund Robinson.

This prize was instituted in 2013 and is awarded annually to one undergraduate student and one postgraduate student in recognition of their achievement in applying the highest quality scientific and engineering principles in the broad area of Distributed Systems. This is the area in which Dr Honda concentrated most of his teaching, and it is also the area in which he conducted his research. Its primary funding comes from a donation from his family, who wished to commemorate Dr Honda in this way. Additional funding has come from Dr Honda's own ETAPS Award. This prize is sponsored by Springer Verlag, and awarded annually by the ETAPS committee in recognition of an individual's research contribution. Dr Honda received the first such award posthumously, and the awarding panel expressed a wish that the funding be used to supplement this prize fund. The laudation for this award, written by Dr Honda's colleague, Prof Vladimiro Sassone is included later.

## About Dr Honda

Kohei Honda was born and lived the first part of his life in Japan. Like many scientists he was fascinated by the idea of finding basic explanatory theories, like the physicists looking for grand unified theories of the universe. Kohei, though, was passionately interested in finding the right basic explanatory theory for the process of computation. Most academics agree that the basic theory



## Winners 2013



**Ms Anna Pawlicka**

2013 winner (Undergraduate) source: QMUL



**Mr. Valdmir Negacevshi**

2013 winner (Postgraduate) source: QMUL

# Session Type Mobility Group

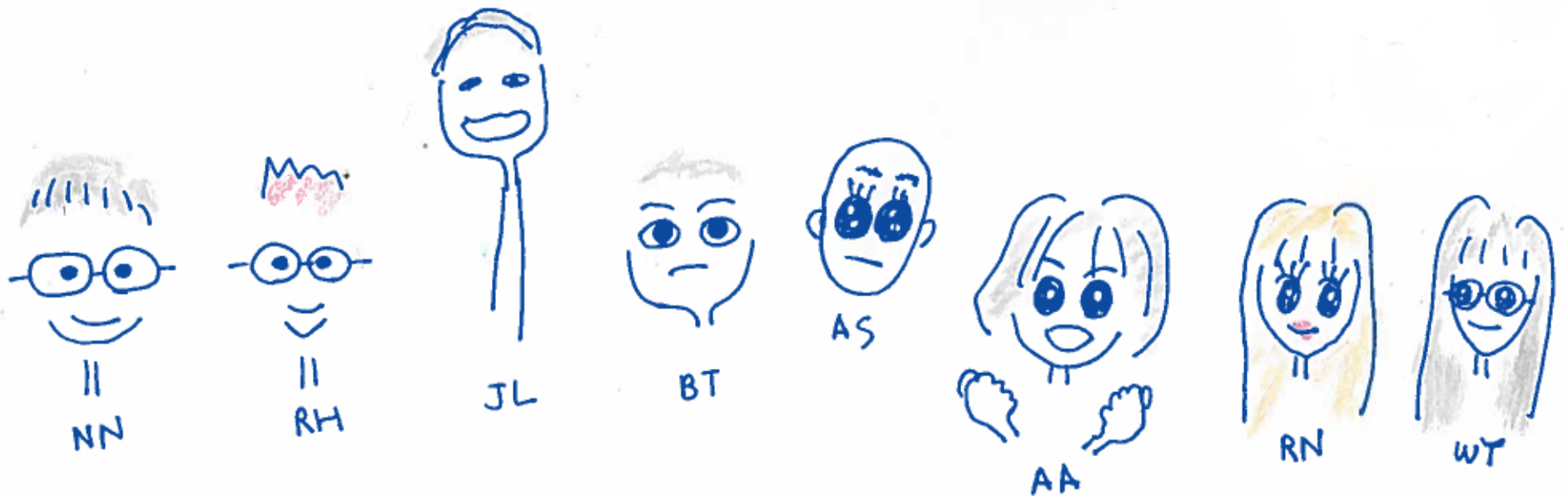

[www.mrg.doc.ic.ac.uk](http://www.mrg.doc.ic.ac.uk)

# Selected Publications 2015/2016



- **[ECOOP'16]** Alceste Scalas, NY: Lightweight Session Programming in Scala.
- **[CC'16]** Nicholas Ng, NY: Static Deadlock Detection for Concurrent Go by Global Session Graph Synthesis.
- **[FASE'16]** Raymond Hu, NY: Hybrid Session Verification through Endpoint API Generation.
- **[TACAS'16]** Julien Lange, NY: Characteristic Formulae for Session Types.
- **[ESOP'16]** Dimitrios Kouzapas, Jorge A. Pérez, NY: On the Relative Expressiveness of Higher-Order Session Processes.
- **[POPL'16]** Dominic Orchard, NY: Effects as Sessions, Sessions as Effects.
- **[FSTTCS'15]** Romain Demangeon, NY: On the Expressiveness of Multiparty Session Types.
- **[OOPSLA'15]** Hugo A. López, Eduardo R. B. Marques, Francisco Martins, Nicholas Ng, César Santos, Vasco Thudichum Vasconcelos, NY: Protocol-Based Verification of Message-Passing Parallel Programs .
- **[CONCUR'15]** Dimitrios Kouzapas, Jorge A. Pérez, NY: Characteristic Bisimulations for Higher-Order Session Processes .
- **[CONCUR'15]** Laura Bocchi, Julien Lange, NY: Meeting Deadlines Together.
- **[CONCUR'15]** Marco Carbone, Fabrizio Montesi, Carsten Schürmann, NY: Multiparty Session Types as Coherence Proofs.
- **[CC'15]** Nicholas Ng, Jose G.F. Coutinho, NY: Protocols by Default: Safe MPI Code Generation based on Session Types.
- **[PPoPP'15]** Tiago Cogumbreiro, Raymond Hu, Francisco Martins, NY: Dynamic Deadlock Verification for General Barrier Synchronisation.
- **[POPL'15]** Julien Lange, Emilio Tuosto, NY: From Communicating Machines to Graphical Choreographies.

# Selected Publications 2015/2016



- **[ECCOOP'16]** Alceste Scalas, NY: Lightweight Session Programming in Scala.
- **[CC'16]** Nicholas Ng, NY: Static Deadlock Detection for Concurrent Go by Global Session Graph Synthesis.
- **[FASE'16]** Raymond Hu, NY: Hybrid Session Verification through Endpoint API Generation.
- **[TACAS'16]** Julien Lange, NY: Characteristic Formulae for Session Types.
- **[ESOP'16]** Dimitrios Kouzapas, Jorge A. Pérez, NY: On the Relative Expressiveness of Higher-Order Session Processes.
- **[POPL'16]** Dominic Orchard, NY: Effects as Sessions, Sessions as Effects .
- **[FSTTCS'15]** Romain Demangeon, NY: On the Expressiveness of Multiparty Session Types.
- **[OOPSLA'15]** Hugo A. López, Eduardo R. B. Marques, Francisco Martins, Nicholas Ng, César Santos Vasco Thudichum Vasconcelos, NY: Protocol-Based Verification of Message-Passing Parallel Programs.
- **[CONCUR'15]** Dimitrios Kouzapas, Jorge A. Pérez, NY: Characteristic Bisimulations for Higher-Order Session Processes .
- **[CONCUR'15]** Laura Bocchi, Julien Lange, Nobuko Yoshida: Meeting Deadlines Together.
- **[CONCUR'15]** Marco Carbone, Fabrizio Montesi, Carsten Schürmann, NY: Multiparty Session Types as Coherence Proofs.
- **[CC'15]** Nicholas Ng, Jose G.F. Coutinho, NY: Protocols by Default: Safe MPI Code Generation based on Session Types.
- **[PPoPP'15]** Tiago Cogumbreiro, Raymond Hu, Francisco Martins, NY: Dynamic Deadlock Verification for General Barrier Synchronisation.
- **[POPL'15]** Julien Lange, Emilio Tuosto, NY: From Communicating Machines to Graphical Choreographies.

## Current: Communication is Ubiquitous

- The way to organise software is increasingly based on communications (Cloud Computing, many cores, message-passing parallel computation, ...)
- **Question**
  - How to **formally** abstract/specify/implement/control communications?
  - How to apply mobile processes and their type theories to real distributed applications and programming languages?

## Current: Communication is Ubiquitous

- The way to organise software is increasingly based on communications (Cloud Computing, many cores, message-passing parallel computation, ...)
- **Question**  $\implies$  **Multiparty session type theory**
  - How to **formally** abstract/specify/implement/control communications?
  - How to apply mobile processes and their type theories to real distributed applications and programming languages?
    - $\implies$  **large-scale cyberinfrastructure for e-Science**

# Ocean Observatories Initiative

- A NSF project (400M\$, 5 Years) to build a cyberinfrastructure for observing oceans around US and beyond.
- Real-time sensor data constantly coming from both off-shore and on-shore (e.g. buoys, submarines, under-water cameras, satellites), transmitted via high-speed networks.

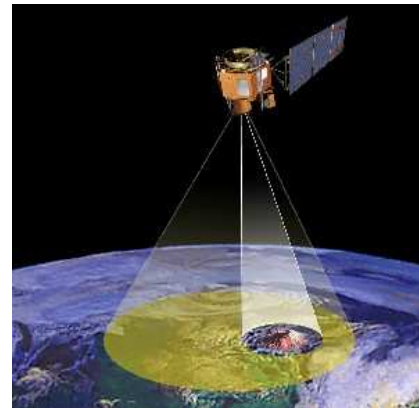
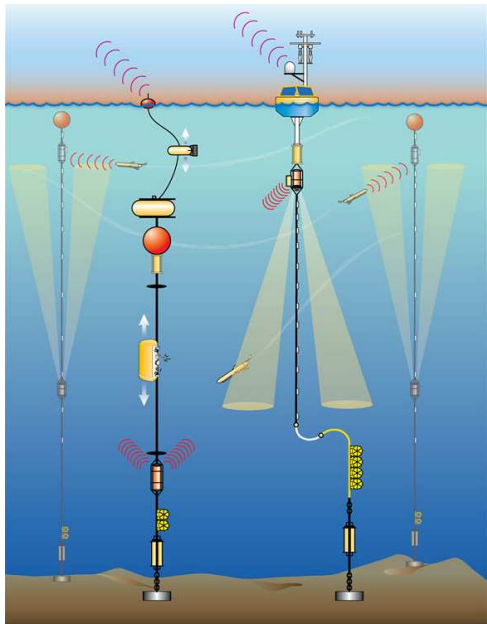

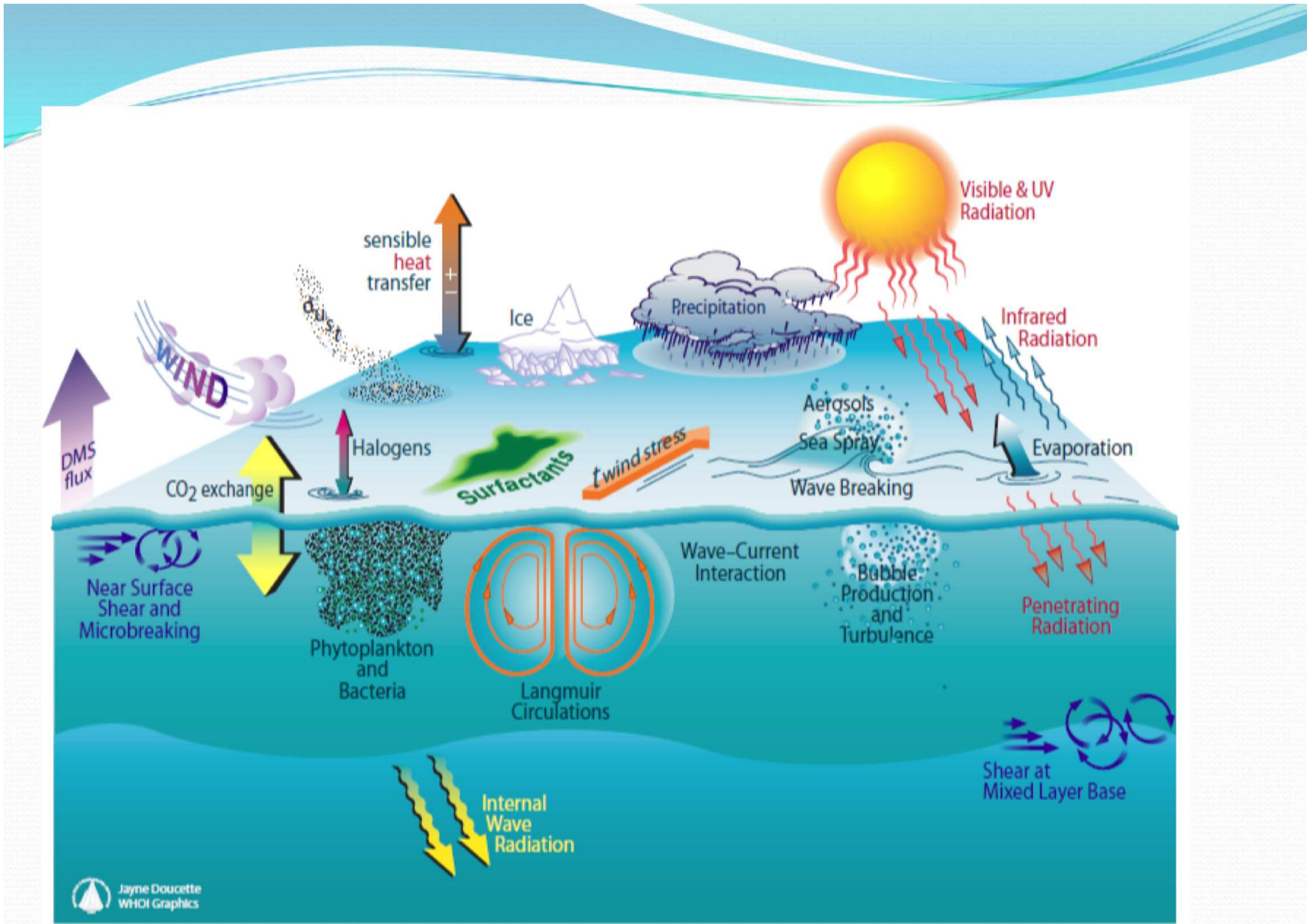

# Ocean Observatories Initiative

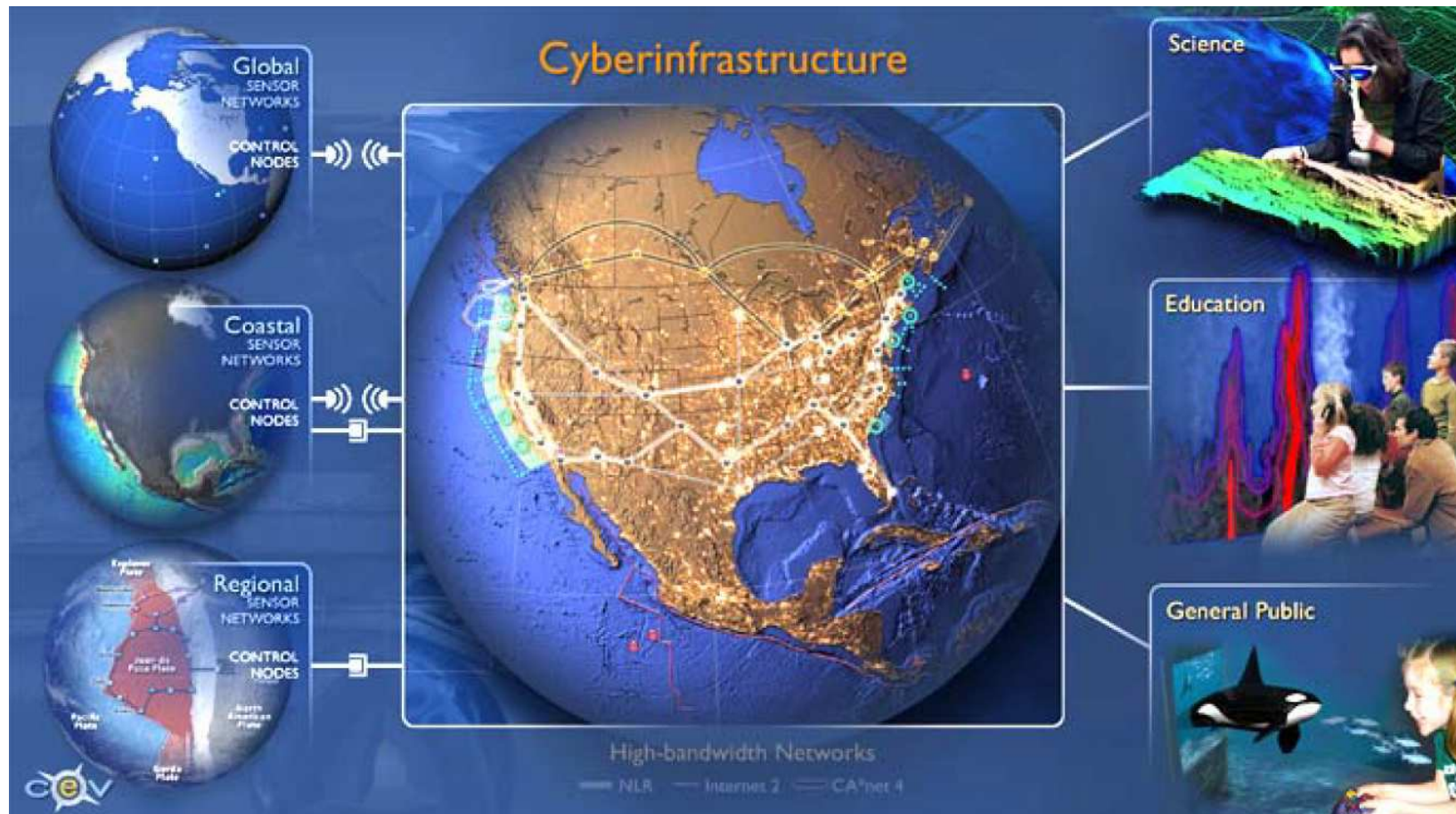

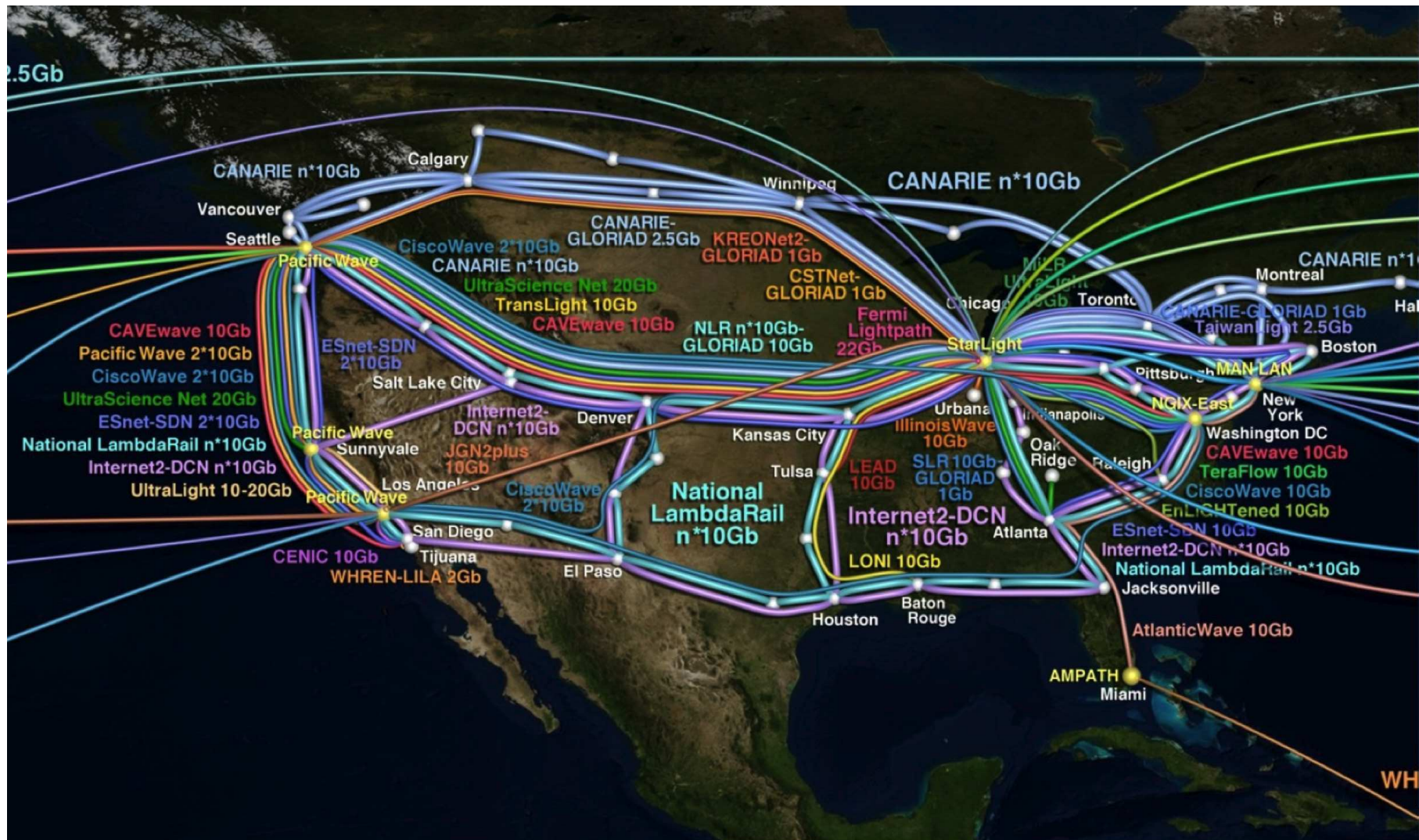

Ocean Observatories Initiative

## Challenges

- The need to specify, catalogue, program, implement and manage *multiparty message passing protocols*.
- Communication assurance
  - Correct message ordering and synchronisation
  - Deadlock-freedom, progress and liveness
  - Dynamic message monitoring and recovery
  - Logical constraints on message values
- Shared and used over a long-term period (e.g. 30 years in OOI).

## Why Multiparty Session Types?

- Robin Milner (2002): *Types are the leaven of computer programming; they make it digestible.*
  - ⇒ Can describe communication protocols as *types*
  - ⇒ Can be materialised as *new communications programming languages* and *tool chains*.
- *Scalable* automatic verifications (deadlock-freedom, safety and liveness) without *state-space explosion problems* (*polynomial time complexity*).
- Extendable to *logical verifications* and flexible *dynamic monitoring*.

# Dialogue between Industry and Academia

Binary Session Types [PARL'94, ESOP'98]



Milner, Honda and Yoshida joined W3C WS-CDL (2002)



Formalisation of W3C WS-CDL [ESOP'07]



Scribble at  $\pi^4$  Technology

# CDL Equivalent

- Basic example:

```
package HelloWorld {
    roleType YouRole, WorldRole;
    participantType You{YouRole}, World{WorldRole};
    relationshipType YouWorldRel between YouRole and WorldRole;
    channelType WorldChannelType with roleType WorldRole;

    choreography Main {
        WorldChannelType worldChannel;

        interaction operation=hello from=YouRole to=WorldRole
            relationship=YouWorldRel channel=worldChannel {
            request messageType=Hello;
        }
    }
}
```

# Scribble Protocol

- *"Scribbling is necessary for architects, either physical or computing, since all great ideas of architectural construction come from that unconscious moment, when you do not realise what it is, when there is no concrete shape, only a whisper which is not a whisper, an image which is not an image, somehow it starts to urge you in your mind, in so small a voice but how persistent it is, at that point you start scribbling" - Kohei Honda 2007*
- **Basic example:**

```
protocol HelloWorld {  
  role You, World;  
  Hello from You to World;  
}
```

# Dialogue between Industry and Academia

Binary Session Types [PARL'94, ESOP'98]



Milner, Honda and Yoshida joined W3C WS-CDL (2002)



Formalisation of W3C WS-CDL [ESOP'07]



Scribble at  $\pi^4$  Technology



Multiparty Session Types [POPL'08]



# Dialogue between Industry and Academia

Binary Session Types [PARL'94, ESOP'98]



Milner, Honda and Yoshida joined W3C WS-CDL (2002)



Formalisation of W3C WS-CDL [ESOP'07]



Scribble at  $\pi^4$  Technology



Multiparty Session Types [POPL'08]



# Binary Session Types : Buyer-Seller Protocol

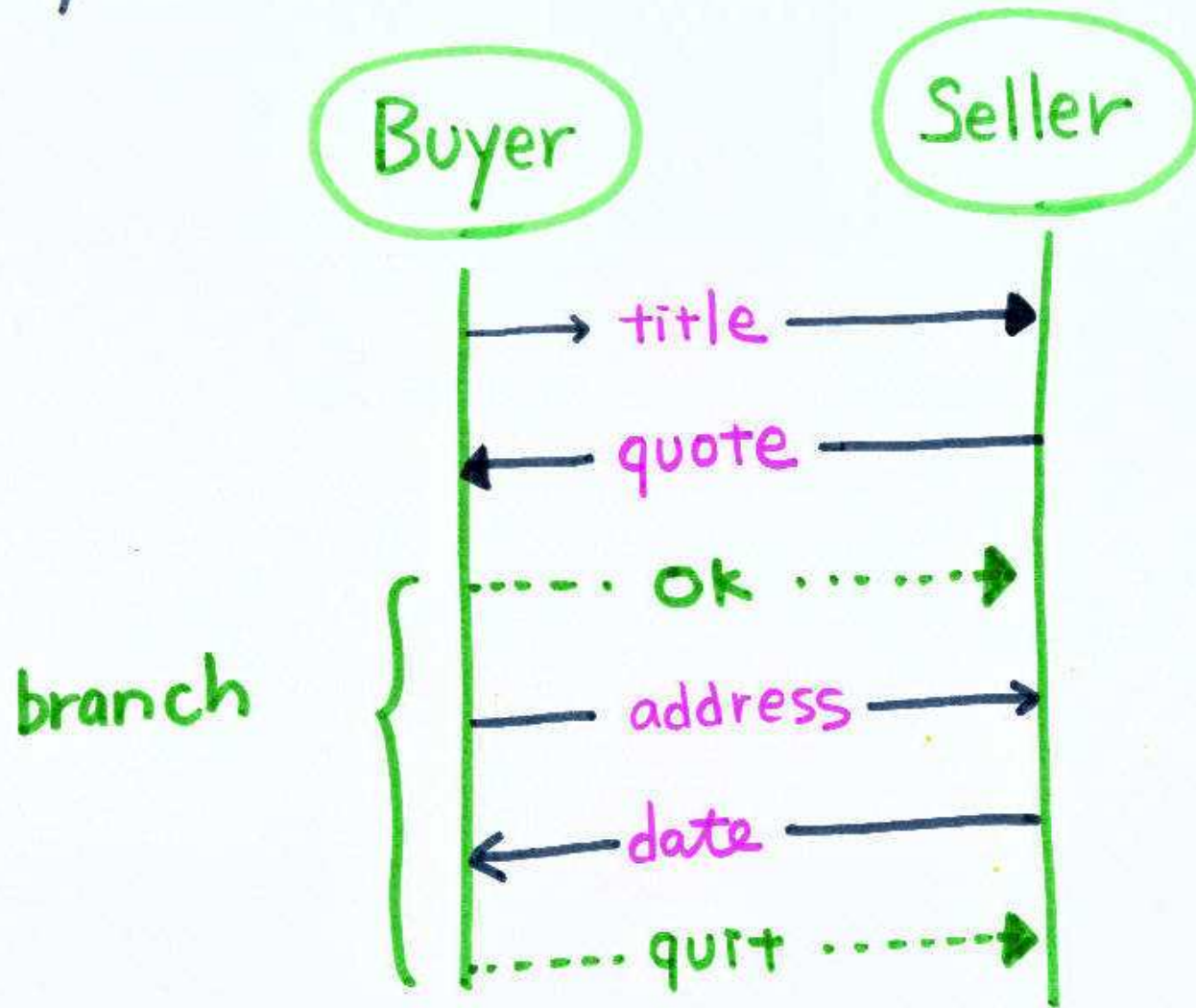

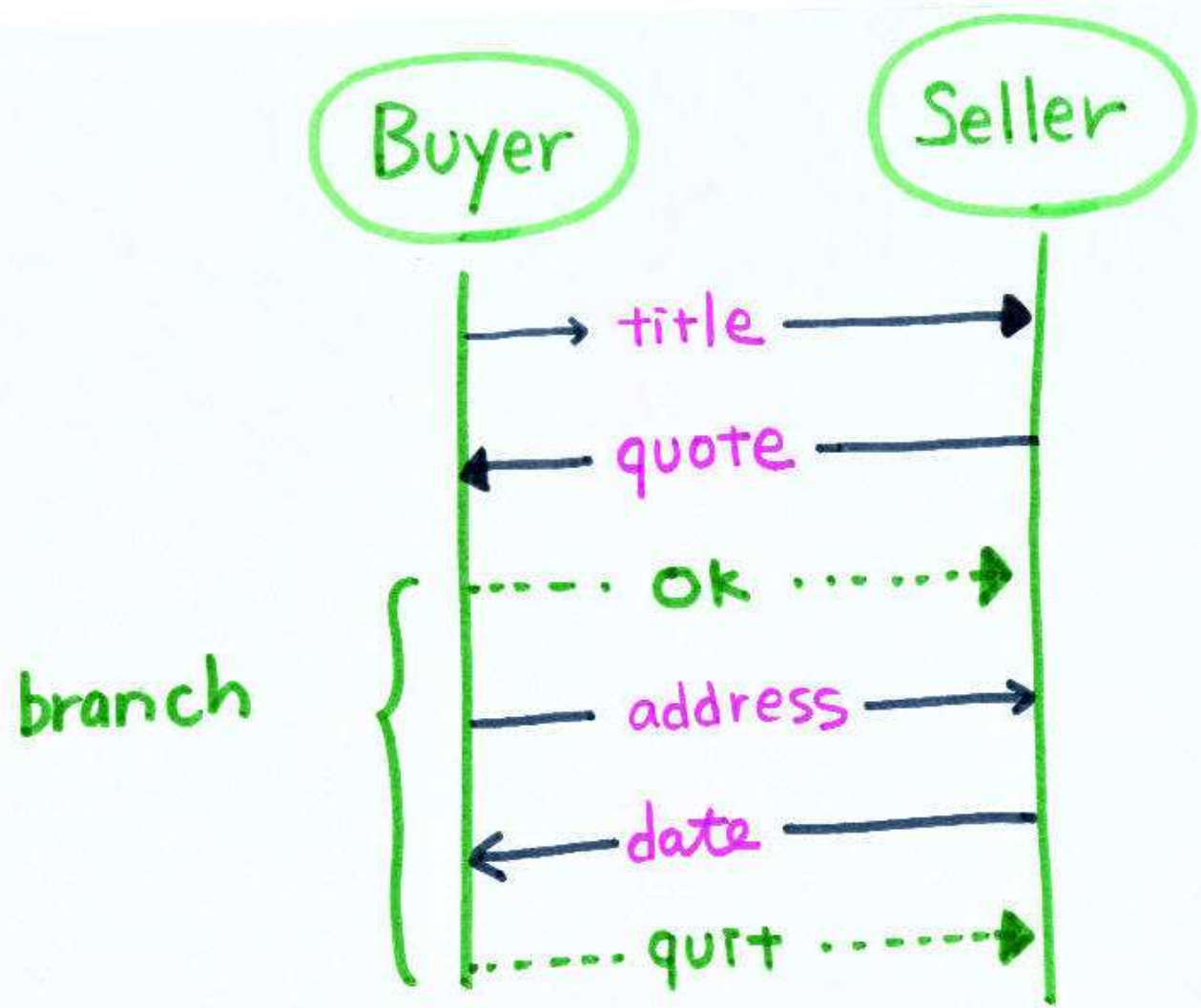

! String ; ? Int ; ⊕ { ok : !String ; ? Date ; end , quit : end }

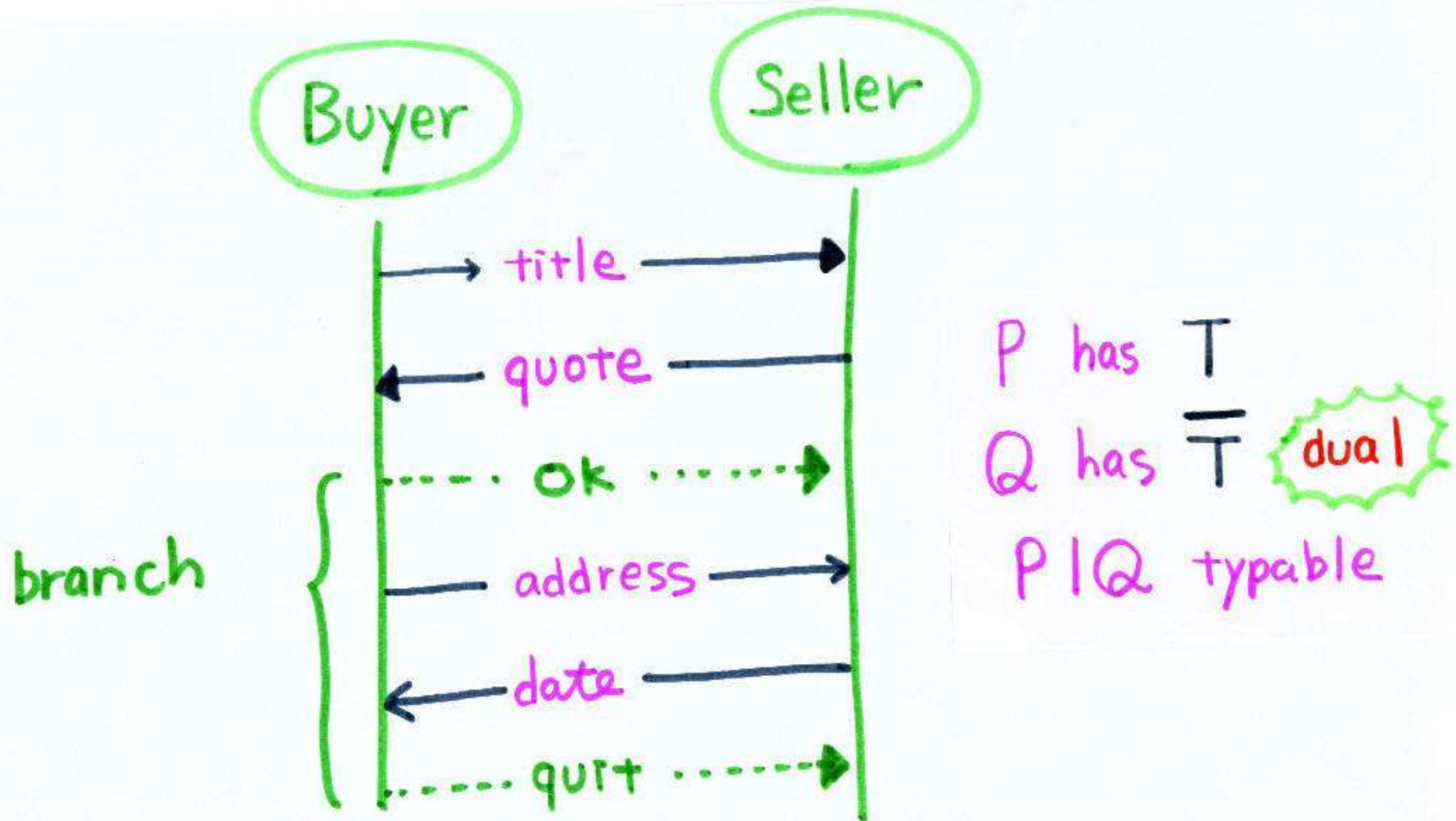

! String ; ? Int ; ⊕ { ok : !String ; ? Date ; end , quit : end }

dual ? String ; ! Int ; & { ok : ?String ; ! Date ; end , quit : end }

# Multiparty Session Types

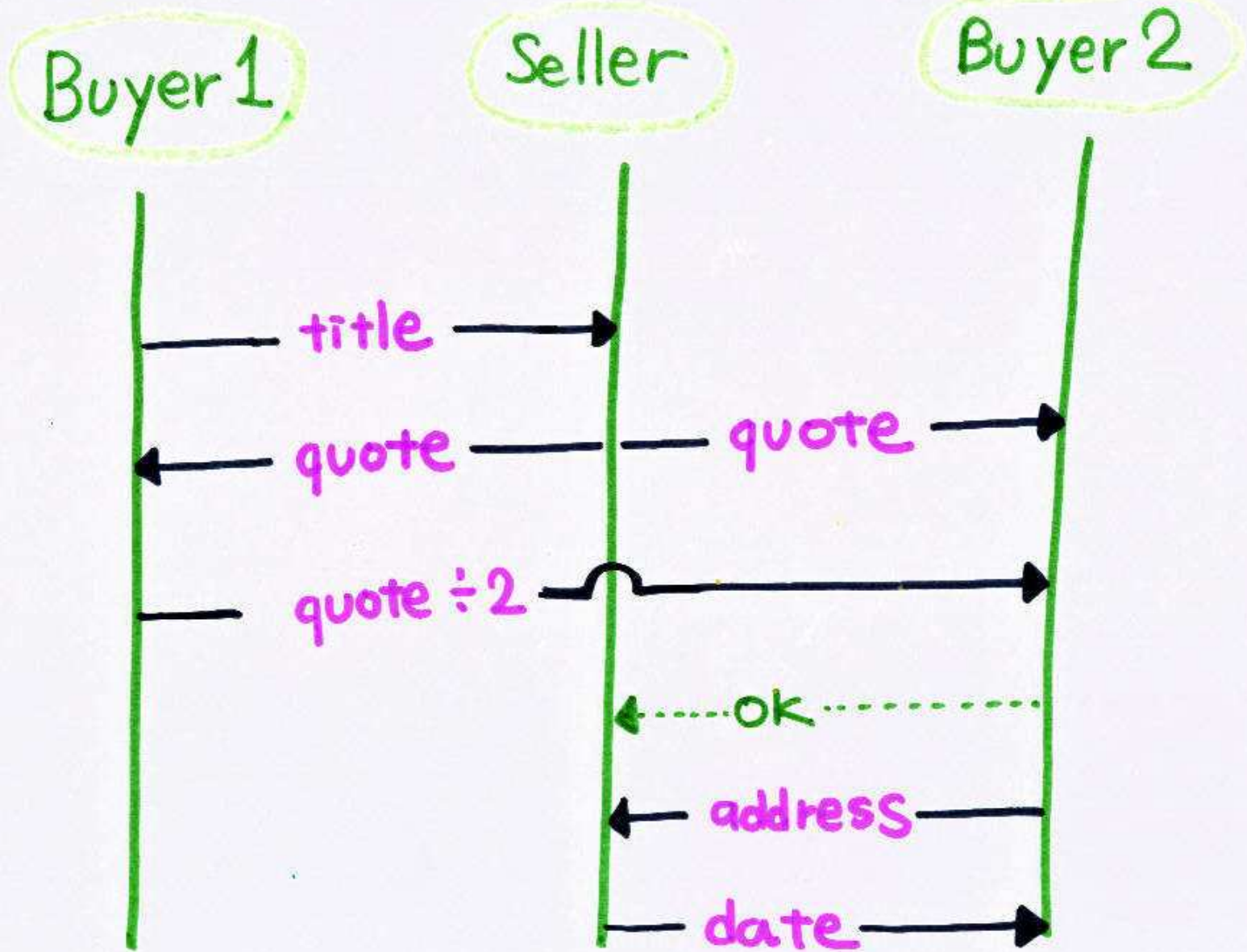

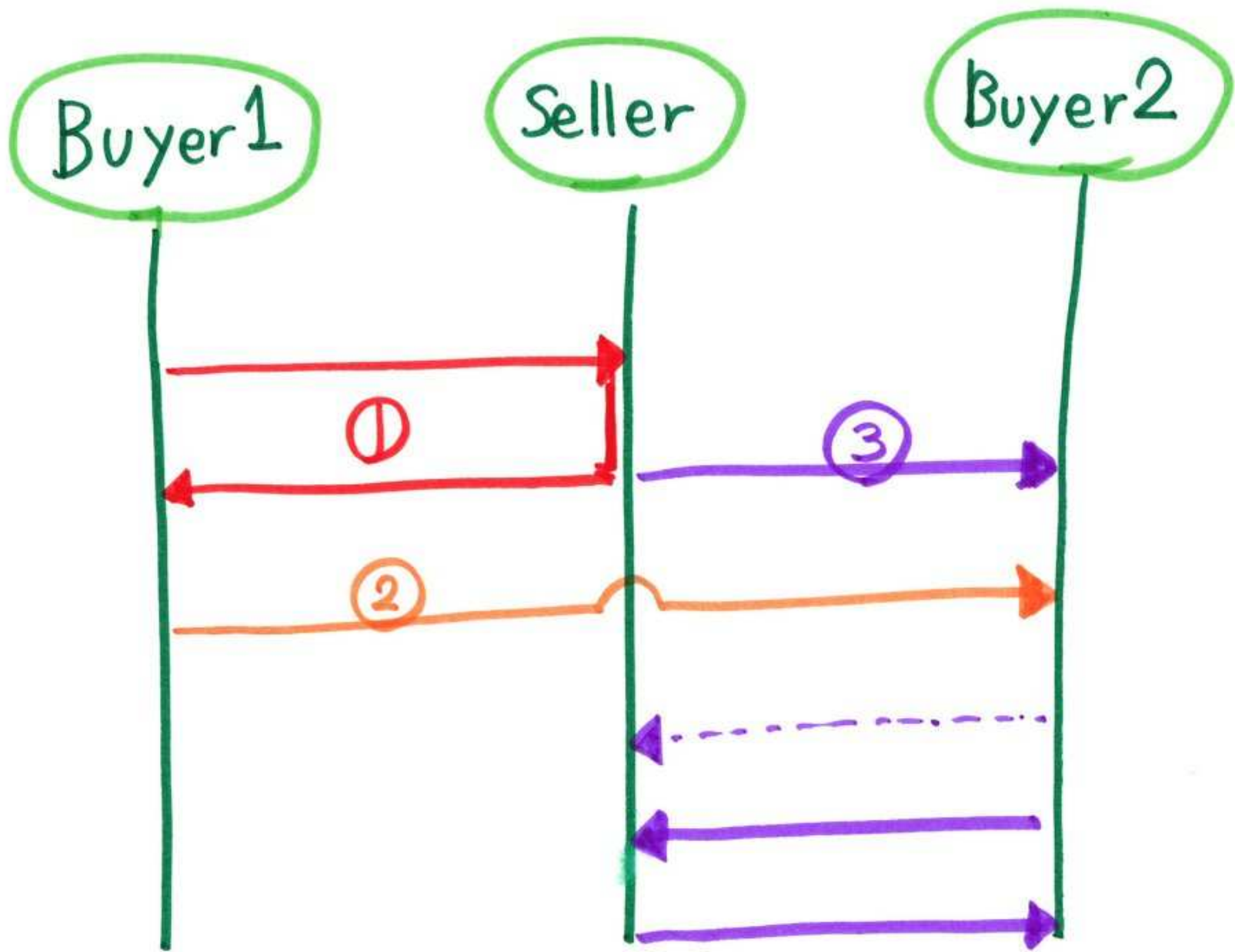

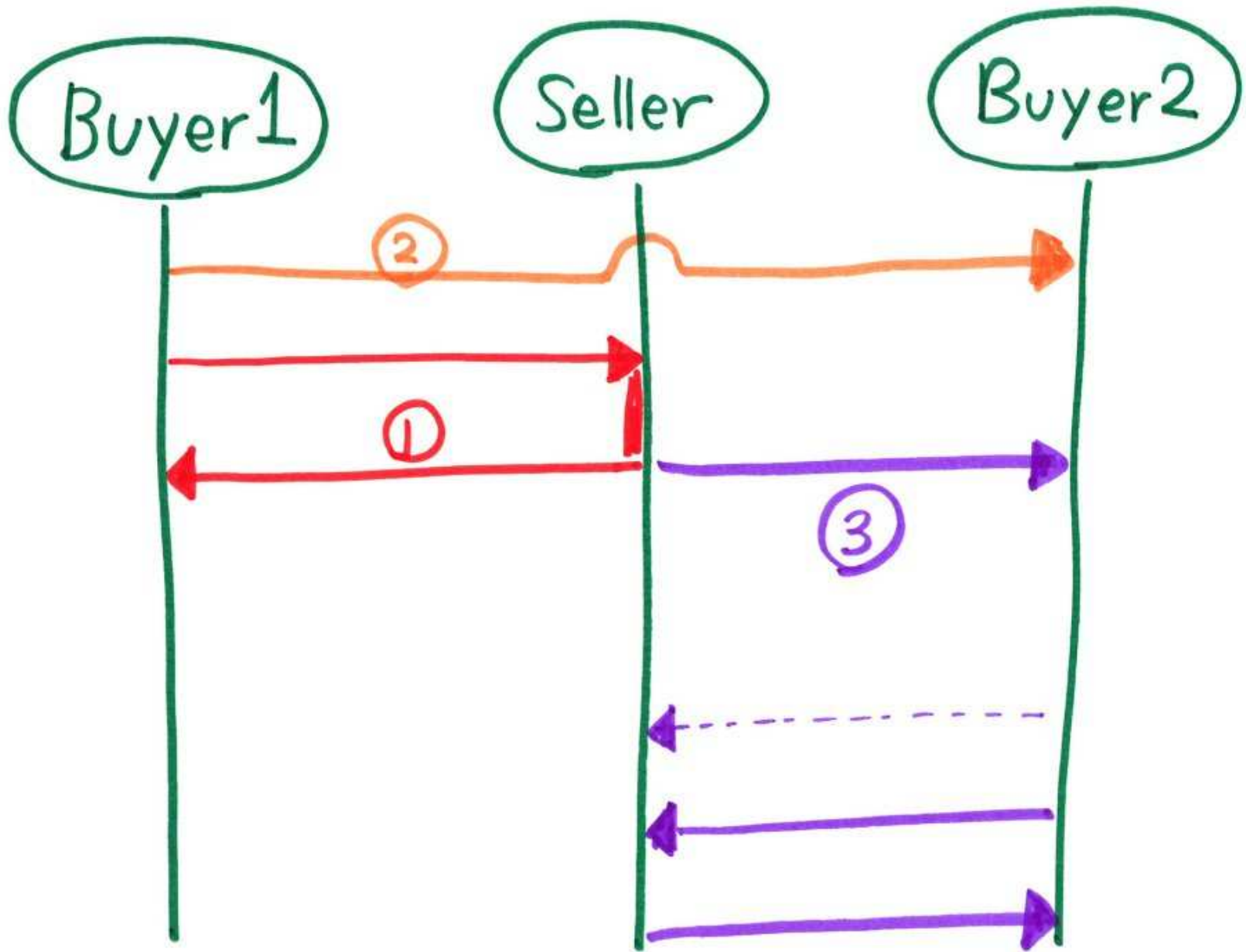

# Multiparty Session Types

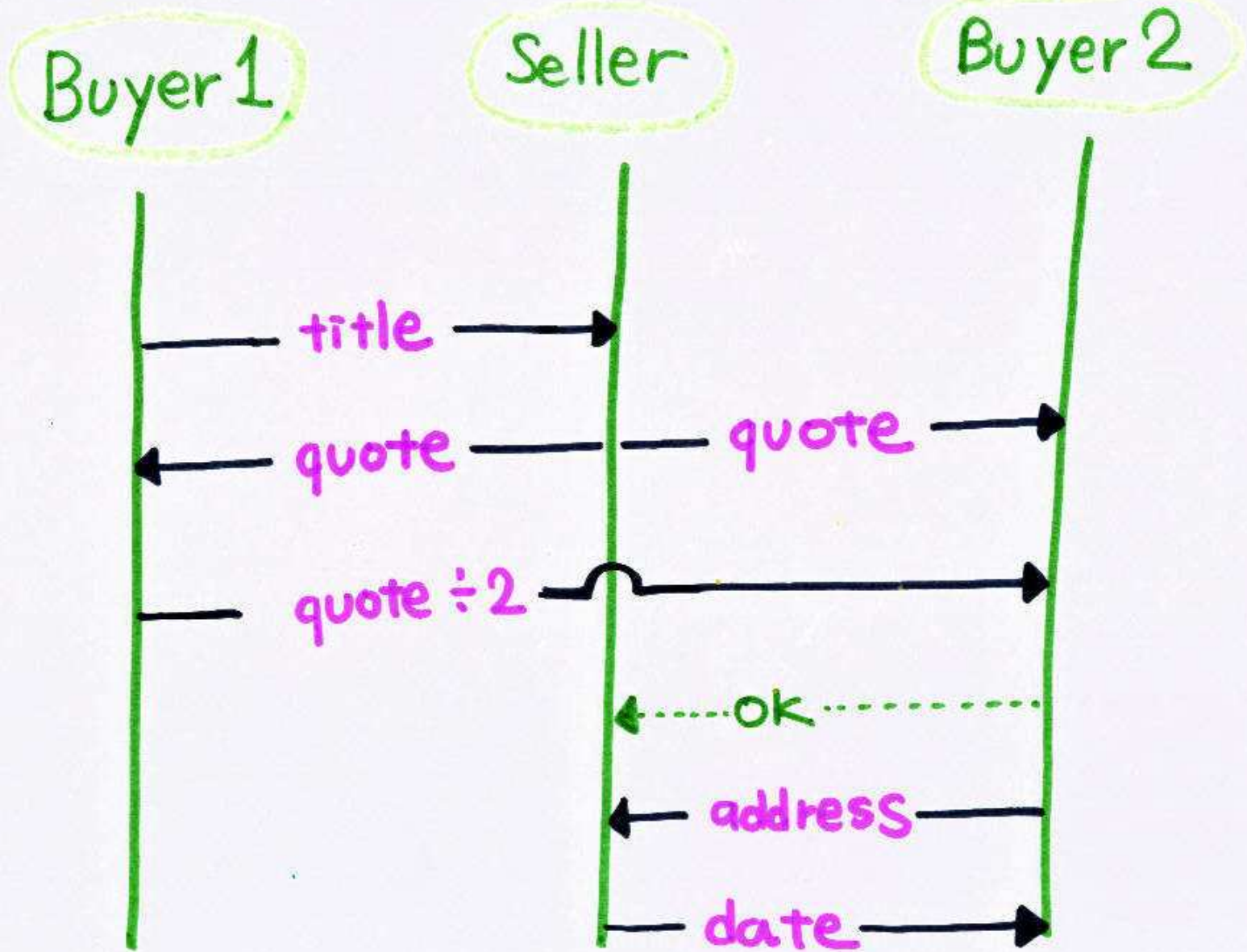

# Multiparty session types

## ► Global Types and End Point Projection (Abstract Choreography)

### ► Potential errors:

- ✗ Communication mismatch: e.g. receiver is sent an unexpected message
- ✗ Protocol violation: executed interaction does not follow the protocol
- ✗ Deadlock: e.g. all endpoints blocked on input

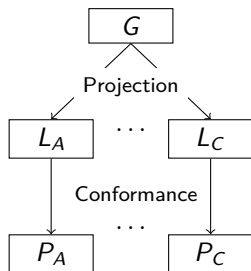

# Multiparty session types

## ► Global Types and End Point Projection (Abstract Choreography)

### ► Potential errors:

- ✗ Communication mismatch: e.g. receiver is sent an unexpected message
- ✗ Protocol violation: executed interaction does not follow the protocol
- ✗ Deadlock: e.g. all endpoints blocked on input

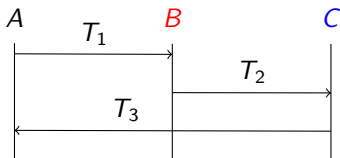
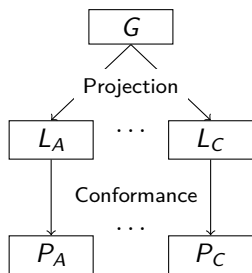

# Multiparty session types

## ► Global Types and End Point Projection (Abstract Choreography)

### ► Potential errors:

- ✗ Communication mismatch: e.g. receiver is sent an unexpected message
- ✗ Protocol violation: executed interaction does not follow the protocol
- ✗ Deadlock: e.g. all endpoints blocked on input

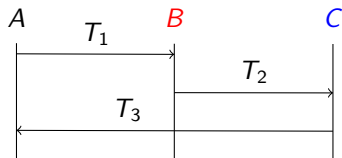
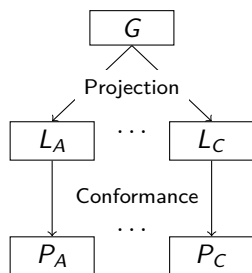

$$G = A \rightarrow B : T_1.$$
$$B \rightarrow C : T_2.$$
$$C \rightarrow A : T_3$$

# Multiparty session types

## ► Global Types and End Point Projection (Abstract Choreography)

### ► Potential errors:

- × Communication mismatch: e.g. receiver is sent an unexpected message
- × Protocol violation: executed interaction does not follow the protocol
- × Deadlock: e.g. all endpoints blocked on input

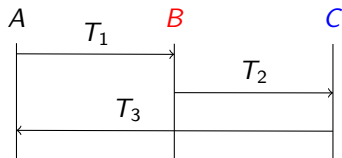
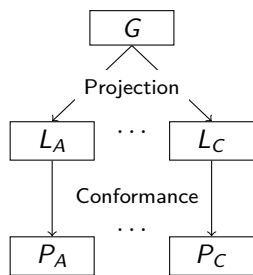
$$G = A \rightarrow B : T_1.$$
$$B \rightarrow C : T_2.$$
$$C \rightarrow A : T_3$$

### Projection (Good)

$$A : !\langle B, T_1 \rangle . ?\langle C, T_3 \rangle$$
$$B : ?\langle A, T_1 \rangle . !\langle C, T_2 \rangle$$
$$C : ?\langle B, T_2 \rangle . !\langle A, T_3 \rangle$$

# Multiparty session types

## ► Global Types and End Point Projection (Abstract Choreography)

### ► Potential errors:

- ✗ Communication mismatch: e.g. receiver is sent an unexpected message
- ✗ Protocol violation: executed interaction does not follow the protocol
- ✗ Deadlock: e.g. all endpoints blocked on input

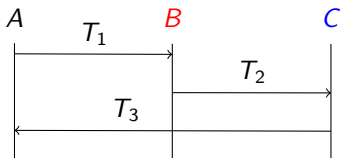
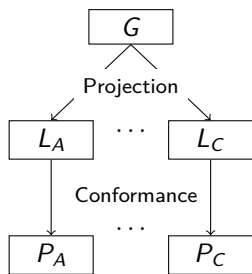

$G = A \rightarrow B : T_1.$   
 $B \rightarrow C : T_2.$   
 $C \rightarrow A : T_3$

### Projection (Good)

$A : !\langle B, T_1 \rangle . ?\langle C, T_3 \rangle$   
 $B : ?\langle A, T_1 \rangle . !\langle C, T_2 \rangle$   
 $C : ?\langle B, T_2 \rangle . !\langle A, T_3 \rangle$

### Bad (Deadlock)

$A : ?\langle C, T_3 \rangle . !\langle B, T_1 \rangle$   
 $B : ?\langle A, T_1 \rangle . !\langle C, T_2 \rangle$   
 $C : ?\langle B, T_2 \rangle . !\langle A, T_3 \rangle$













# Dynamic Monitoring

[RV'13, COORDINATION'14, FMSD'15]

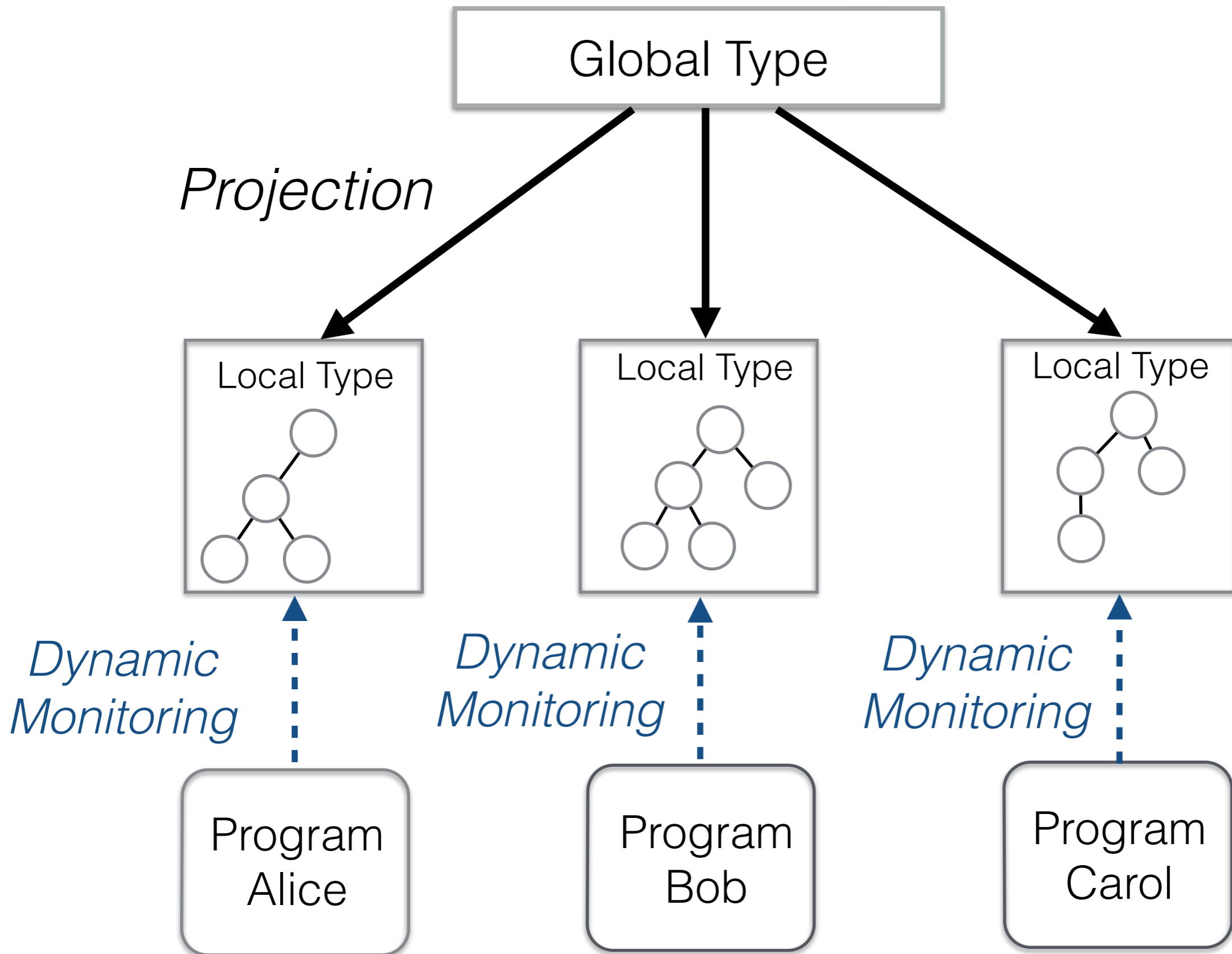



# Two Buyer Protocol in Scribble

```
type <java> "java.lang.String" from "rt.jar" as String
```

```
global protocol TwoBuyers(role A, role B, role S) {  
  title(String) from A to S;  
  quote(Integer) from S to A, B;  
  rec LOOP {  
    share(Integer) from A to B;  
    choice at B {  
      accept(address:String) from B to A,  
      date(String) from S to B;  
    } or {  
      retry() from B to A, S;  
      continue LOOP;  
    } or {  
      quit() from B to A, S;  
    }  
  }  
}
```

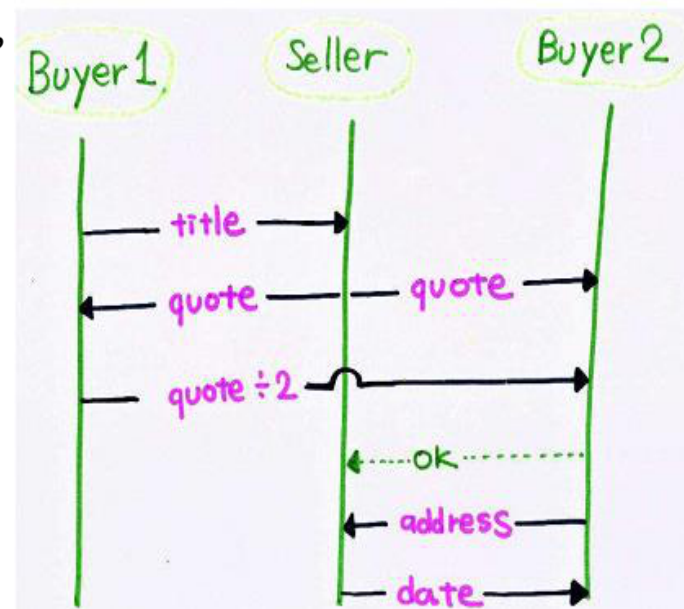



# Buyer: A local projection

---

```
module Bookstore_TwoBuyers_A;

type <java> "java.lang.Integer" from "rt.jar" as Integer;
type <java> "java.lang.String" from "rt.jar" as String;

local protocol TwoBuyers_A at A(role A, role B, role S) {
  title(String) to S;
  quote(Integer) from S;
  rec LOOP {
    share(Integer) to B;
    choice at B {
      accept(address:String) from B;
    } or {
      retry() from B;
      continue LOOP;
    } or {
      quit() from B;
    }
  }
}
```



# OOI agent negotiation 1/5

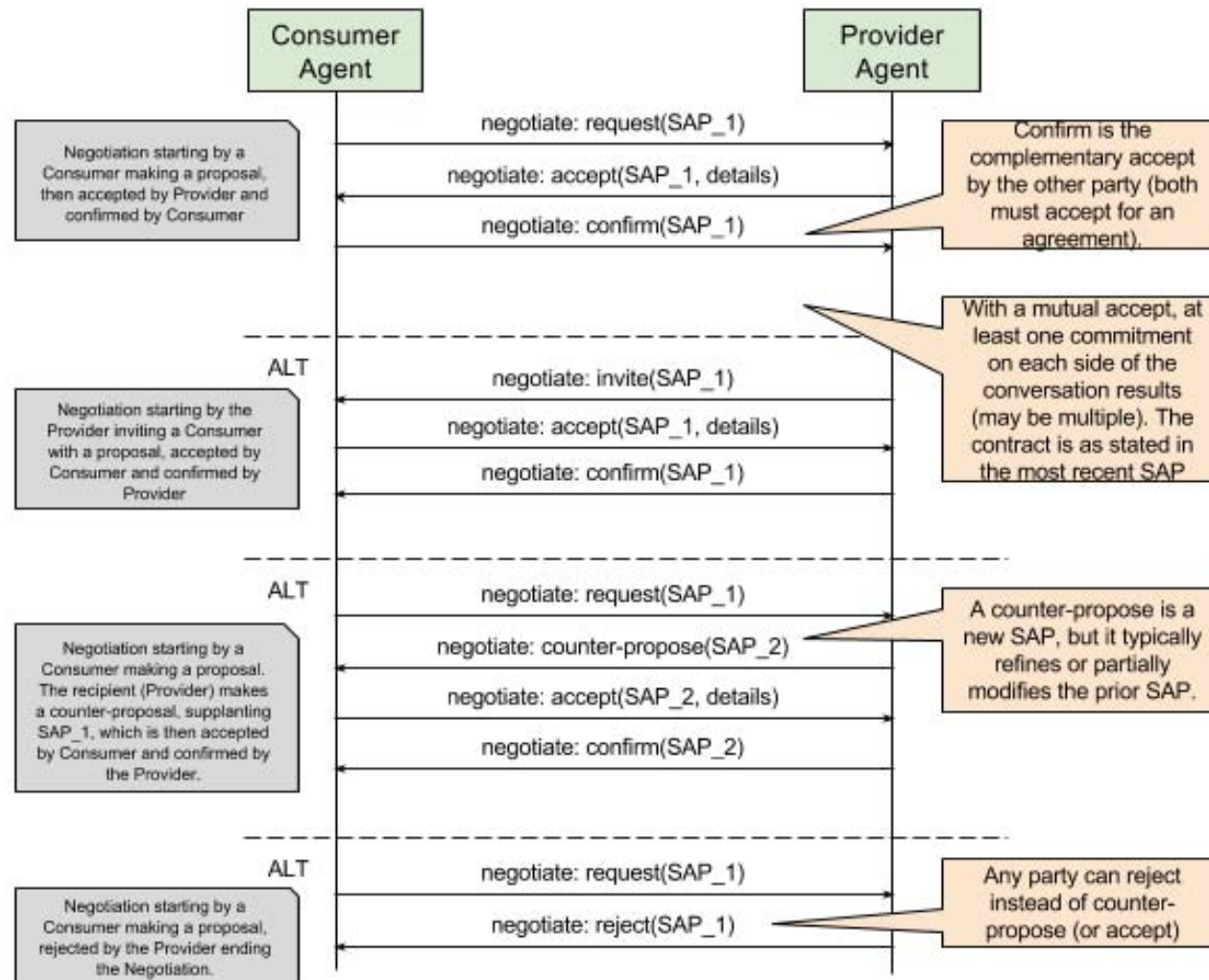

- ▶ <https://confluence.oceanobservatories.org/display/syseng/CIAD+COI+OV+Negotiate+Protocol>

# OOI agent negotiation 2/5

```
type <yml> "SAPDoc1" from "SAPDoc1.yml" as SAP;
```

```
global protocol Negotiate(role Consumer as C, role Producer as P) {
```

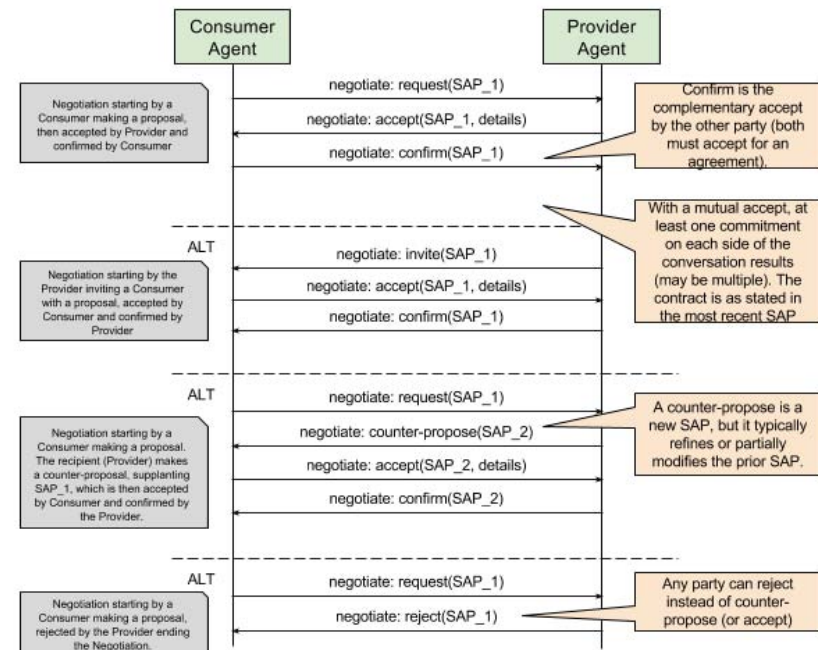

```
}
```

# OOI agent negotiation 3/5 (choice)

```
type <yml> "SAPDoc1" from "SAPDoc1.yml" as SAP;
```

```
global protocol Negotiate(role Consumer as C, role Producer as P) {
  propose(SAP) from C to P;
```

```
  choice at P {
    accept() from P to C;
    confirm() from C to P;
  } or {
    reject() from P to C;
  } or {
    propose(SAP) from P to C;
```

```
  } }
```

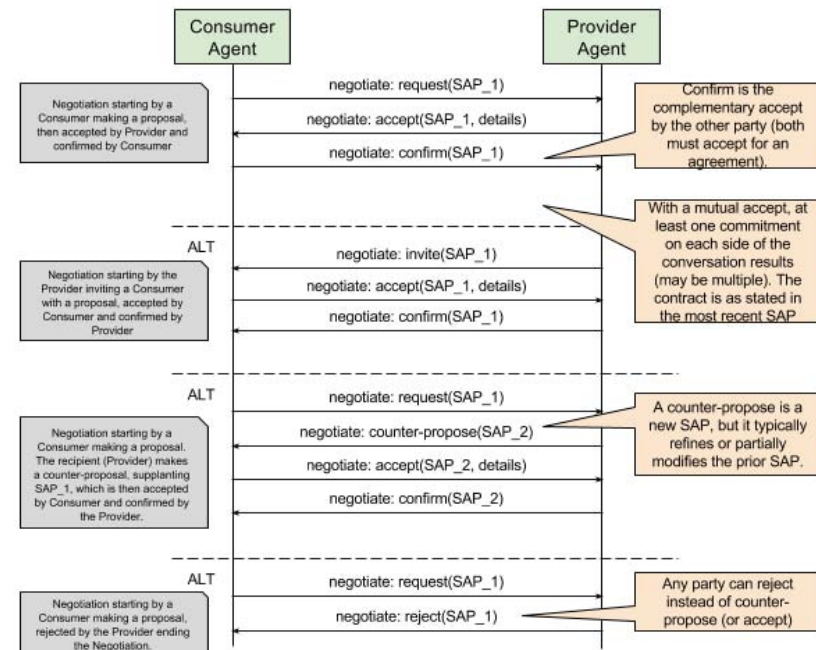

# OOI agent negotiation 4/5

```
type <yml> "SAPDoc1" from "SAPDoc1.yml" as SAP;
```

```
global protocol Negotiate(role Consumer as C, role Producer as P) {
  propose(SAP) from C to P;
```

```
  choice at P {
    accept() from P to C;
    confirm() from C to P;
  } or {
    reject() from P to C;
  } or {
    propose(SAP) from P to C;
    choice at C {
      accept() from C to P;
      confirm() from P to C;
    } or {
      reject() from C to P;
    } or {
      propose(SAP) from C to P;
    }
  }
}
```

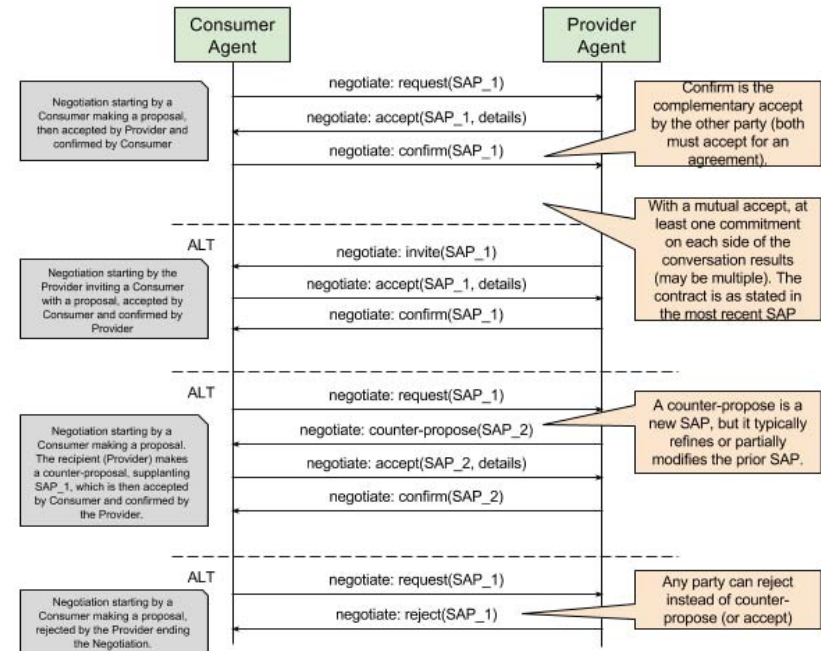

# OOI agent negotiation 5/5 (recursion)

```
type <yml> "SAPDoc1" from "SAPDoc1.yml" as SAP;
```

```
global protocol Negotiate(role Consumer as C, role Producer as P) {
  propose(SAP) from C to P;
  rec X {
    choice at P {
      accept() from P to C;
      confirm() from C to P;
    } or {
      reject() from P to C;
    } or {
      propose(SAP) from P to C;
      choice at C {
        accept() from C to P;
        confirm() from P to C;
      } or {
        reject() from C to P;
      } or {
        propose(SAP) from C to P;
        continue X;
      }
    }
  }
}
```

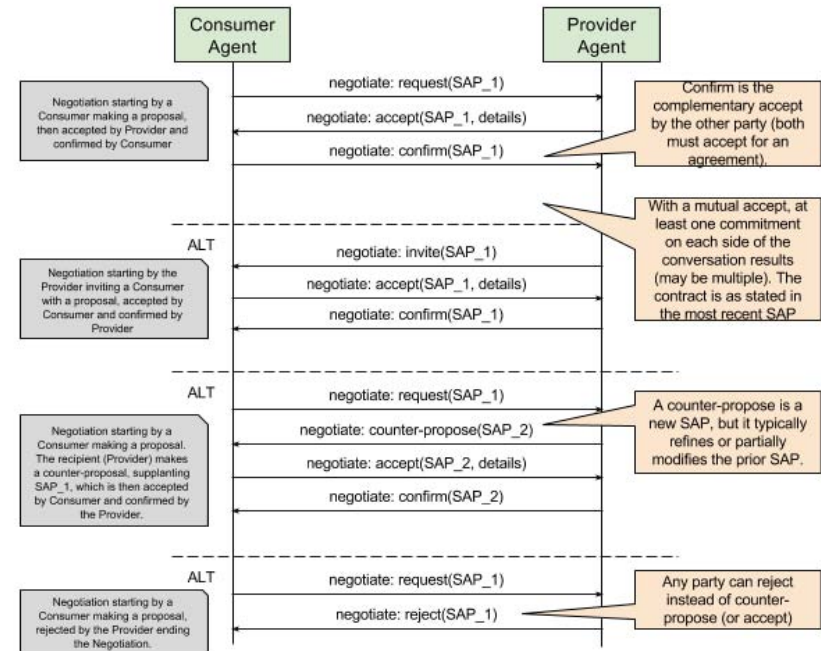

# Local protocol projection (Negotiation Consumer)

```
// Global
propose(SAP) from C to P;
rec START {
  choice at P {
    accept() from P to C;
    confirm() from C to P;
  } or {
    reject() from P to C;
  } or {
    propose(SAP) from P to C;
    choice at C {
      accept() from C to P;
      confirm() from P to C;
    } or {
      reject() from C to P;
    } or {
      propose(SAP) from C to P;
      continue START;
    }
  }
}
```

```
// Projection for Consumer
propose(SAP) to P;
rec START {
  choice at P {
    accept() from P;
    confirm() to P;
  } or {
    reject() from P;
  } or {
    propose(SAP) from P;
    choice at C {
      accept() to P;
      confirm() from P;
    } or {
      reject() to P;
    } or {
      propose(SAP) to P;
      continue START;
    }
  }
}
```

# FSM generation (Negotiation Consumer)

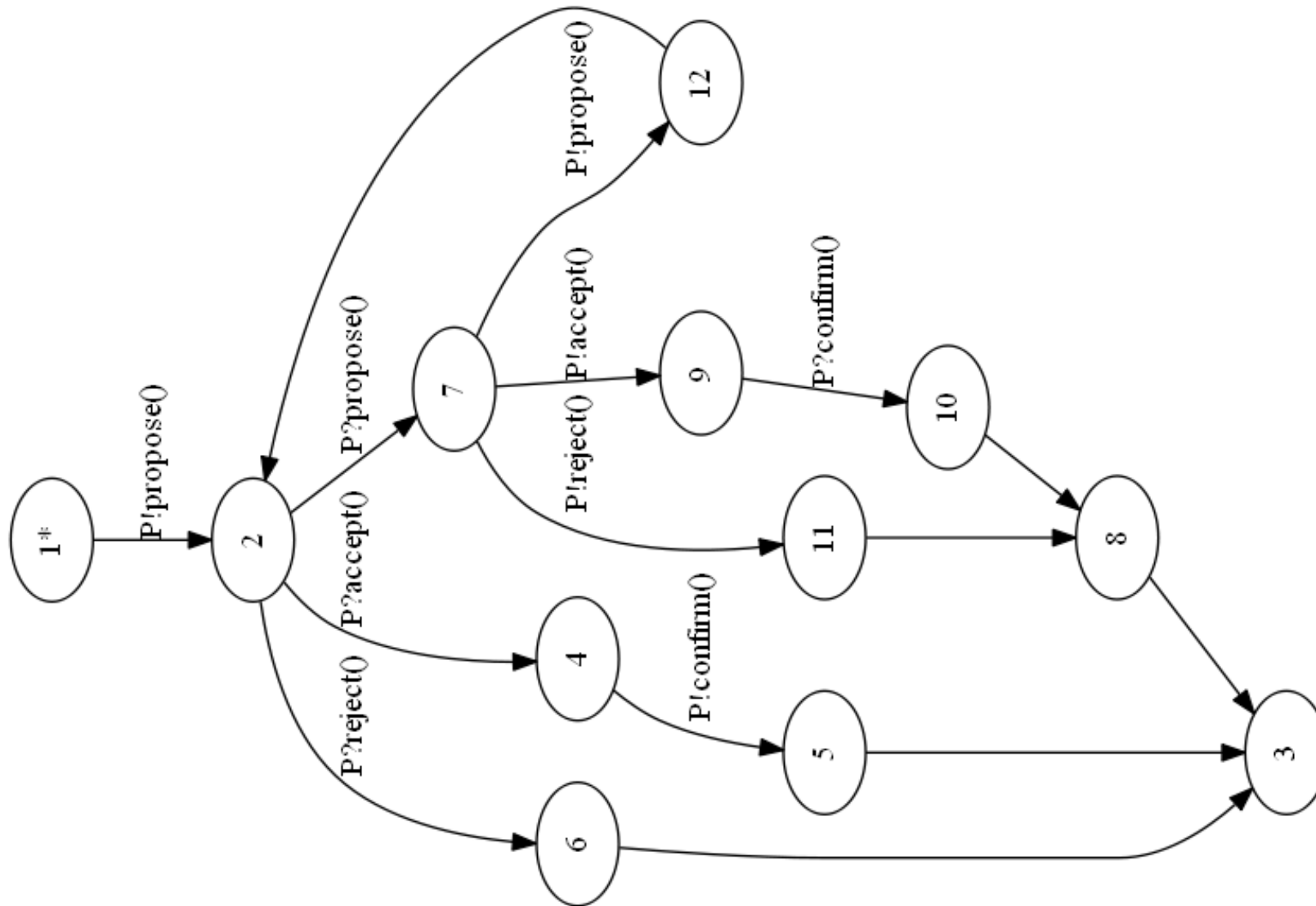



# Scribble Community

---

- ▶ **Webpage:**
  - ▶ [www.scribble.org](http://www.scribble.org)
- ▶ **GitHub:**
  - ▶ <https://github.com/scribble>
- ▶ **Tutorial:**
  - ▶ [www.doc.ic.ac.uk/~rhu/scribble/tutorial.html](http://www.doc.ic.ac.uk/~rhu/scribble/tutorial.html)
- ▶ **Specification (0.3)**
  - ▶ [www.doc.ic.ac.uk/~rhu/scribble/langref.html](http://www.doc.ic.ac.uk/~rhu/scribble/langref.html)



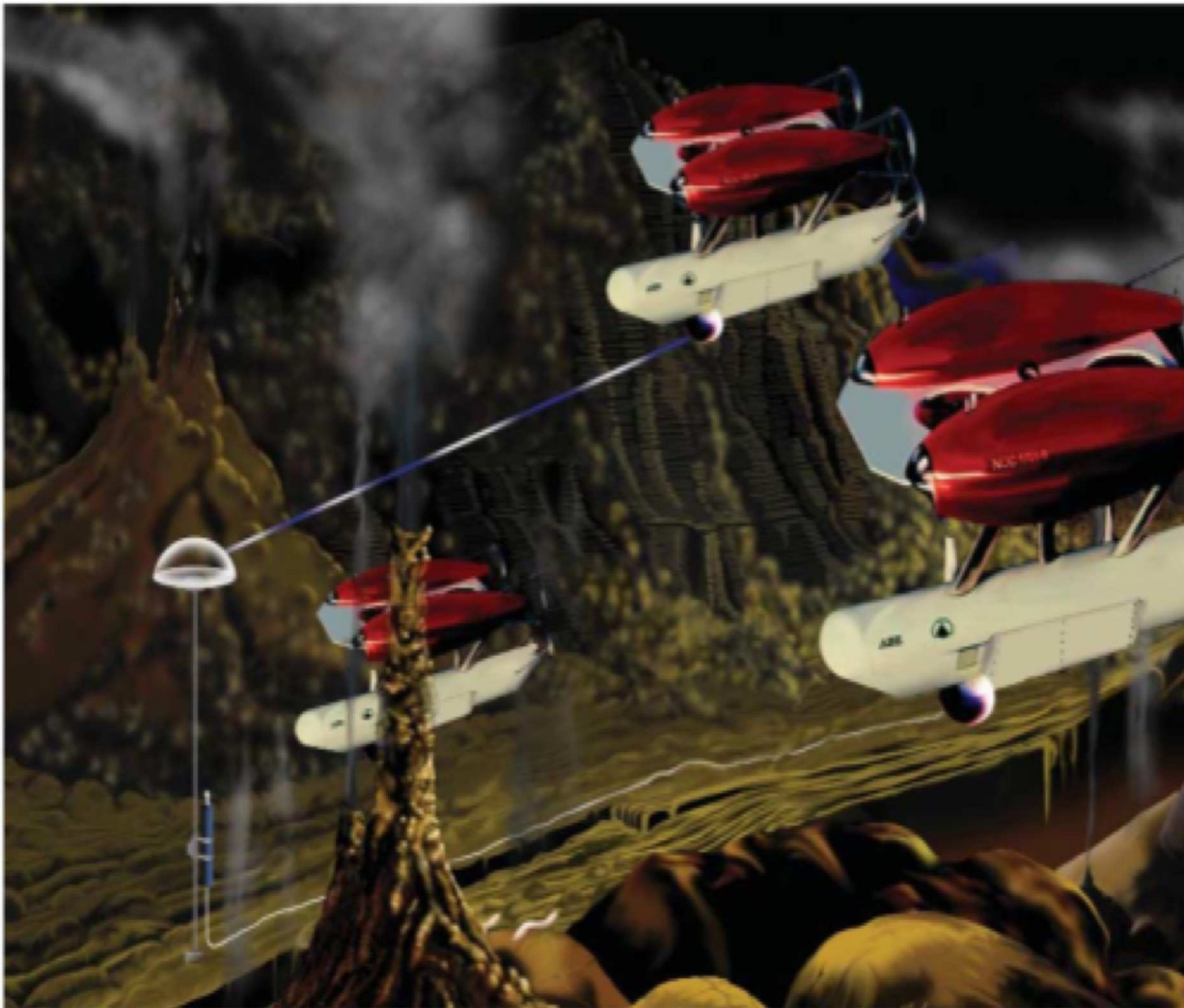

**Figure 5: A coordinated set of autonomous underwater vehicles**



**Figure 3: Observatory comprised of ships, aircraft and autonomous vehicles linked to assimilation modeling capabilities on shore**



Location CURRENT LOCATION

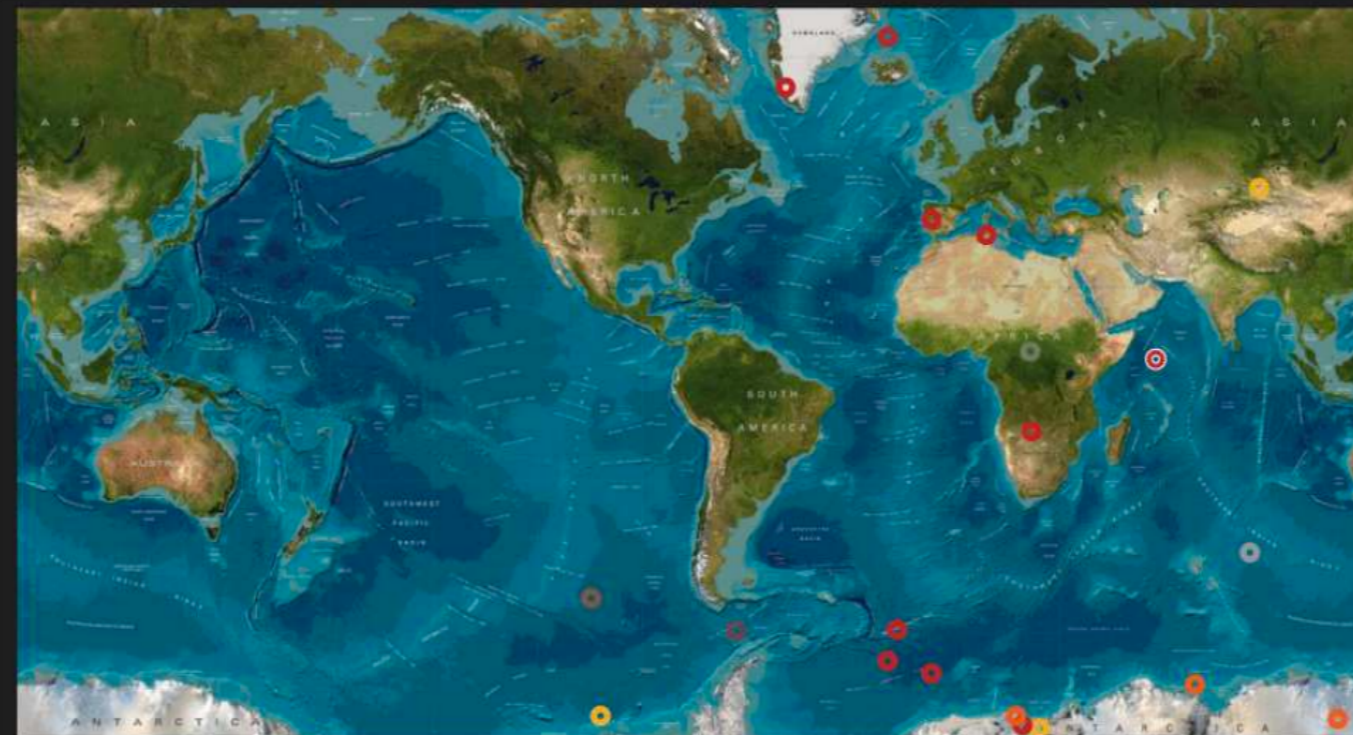

SEARCH

RESOURCES

- All Resources
- Data Products
- Observatories
- Platforms
- Instruments

Welcome to Release 2 of the Ocean Observatories Initiative Observatory (OOI). You already have access to many OOI features and real-time data. Just click on something that looks interesting on this page to start using the OOI as our Guest.

For personalized services, such as setting up notifications and preserving settings for your next visit, create a free account by clicking on "Create Account" at the top of the page.



National Science Foundation working with Consortium for Ocean Leadership

Funding for the Ocean Observatories Initiative is provided by the National Science Foundation through a Cooperative Agreement with the Consortium for Ocean Leadership. The OOI Program Implementing Organizations are funded through sub-awards from the Consortium for Ocean Leadership.

DATA LEGEND

- Temperature
- Salinity
- Oxygen
- Density
- Currents
- Sea Surface Height (SSH)
- Chlorophyll
- Turbidity
- pH
- Seismology
- Other

REGENCY

- 1 Hour
- 2 hours
- 3 hours
- 5 hours
- 8 hours
- 12 hours
- 18 hours
- 24 hours
- 48 Hours
- 72 Hours

RECENT UPDATES

NAME	DATE	TYPE	EVENT	DESCRIPTION	NOTE
01 m Oregon Coast North Salinity	2012-01-10 23:55:55	Type	Event	Description goes here	Note goes here
01 m California South 100m pH	2012-01-10 23:55:55	Type	Event	Description goes here	Note goes here
01 m California South salinity	2012-01-10 23:55:55	Type	Event	Description goes here	Note goes here
03 m Oregon North Turbidity	2012-01-10 23:55:55	Type	Event	Description goes here	Note goes here
05 m Oregon South Temperature	2012-01-10 23:55:55	Type	Event	Description goes here	Note goes here
20 m Oregon Coast Currents	2012-01-10 23:55:55	Type	Event	Description goes here	Note goes here
01 h California South Seismology	2012-01-10 23:55:55	Type	Event	Description goes here	Note goes here
01 h Oregon Coast South 1000m Ox	2012-01-10 23:55:55	Type	Event	Description goes here	Note goes here
02 h California Coast Seismology	2012-01-10 23:55:55	Type	Event	Description goes here	Note goes here
04 h California North Seismology	2012-01-10 23:55:55	Type	Event	Description goes here	Note goes here

Dashboard

RECENT IMAGES

- Glider**  
Last Modified: 2011-06-15  
Last Viewed: 2011-12-15  
Last Updated: 2011-12-30, 13.24
- Gorgonian Coral**  
Last Modified: 2011-06-15  
Last Viewed: 2011-12-15  
Last Updated: 2011-12-30, 13.24
- Acoustic Release**  
Last Modified: 2011-06-15  
Last Viewed: 2011-12-15  
Last Updated: 2011-12-30, 13.24

POPULAR RESOURCES

- SeaBird CDT**  
Last Modified: 2011-06-15  
Last Viewed: 2011-12-15  
Last Updated: 2011-12-30, 13.24
- Marine caption**  
Last Modified: 2011-06-15  
Last Viewed: 2011-12-15  
Last Updated: 2011-12-30, 13.24
- Surface Buoy**  
Last Modified: 2011-06-15  
Last Viewed: 2011-12-15  
Last Updated: 2011-12-30, 13.24

UNUSUAL EVENTS

- Oregon Coast Wave Height**  
Last Modified: 2011-06-15  
Last Viewed: 2011-12-15  
Last Updated: 2011-12-30, 13.24
- Water Surface Elevation**  
Last Modified: 2011-06-15  
Last Viewed: 2011-12-15  
Last Updated: 2011-12-30, 13.24

FACEPAGE RELATED COMPOSITE STATUS

LYCEBYE BEYALD COMBOIIE ZIAITZ

# Turtles: Protocol-Based Foundations for Distributed Multiagent Systems

# Applications

## OOI Governance

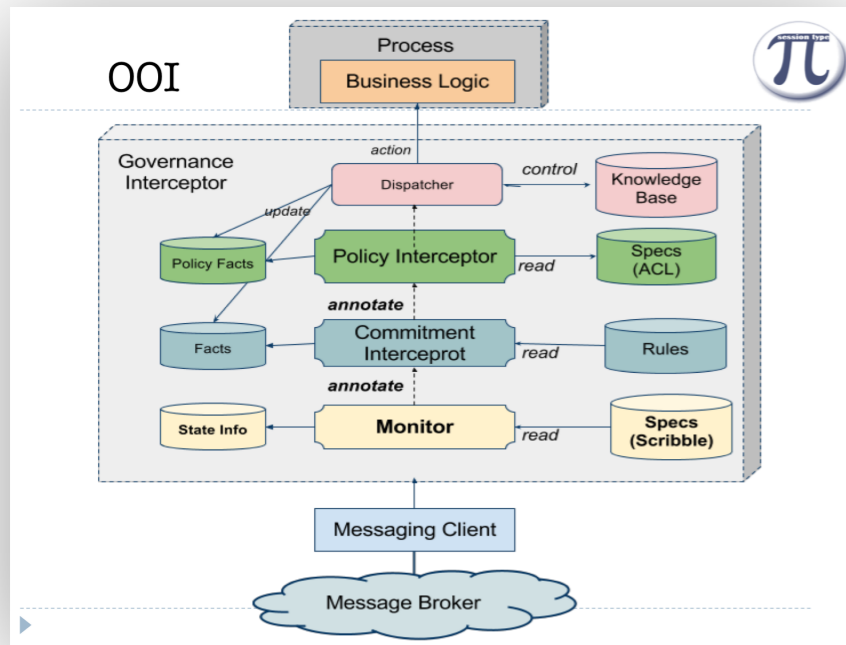

## ZDLC: Process Modeling

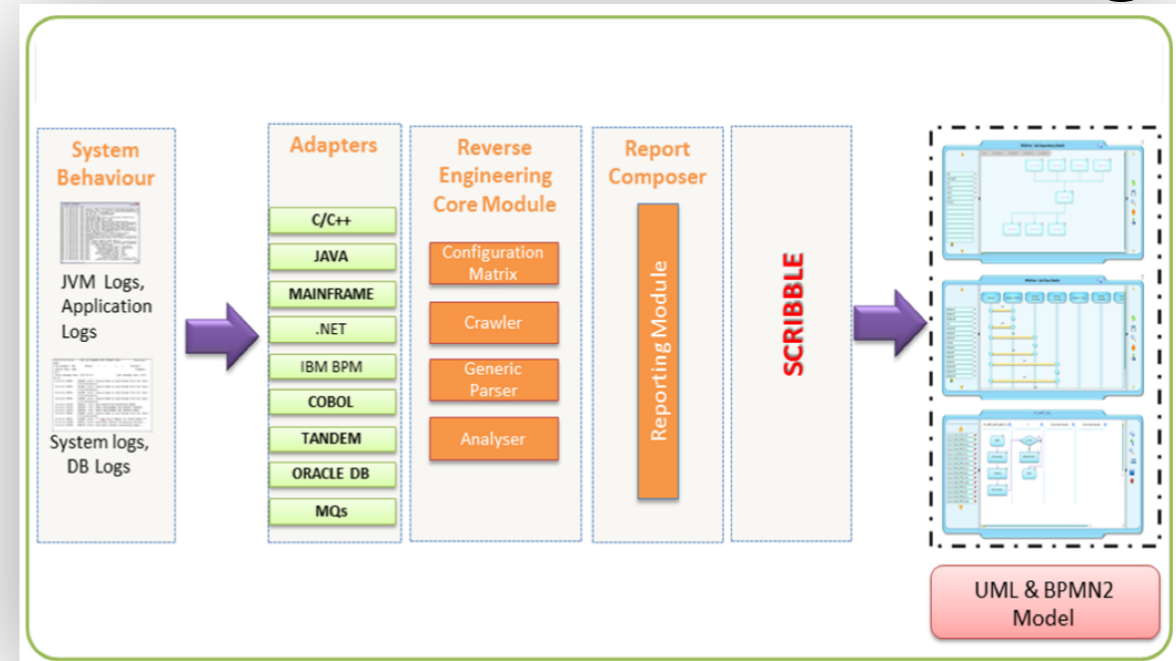

## Protocol Verification

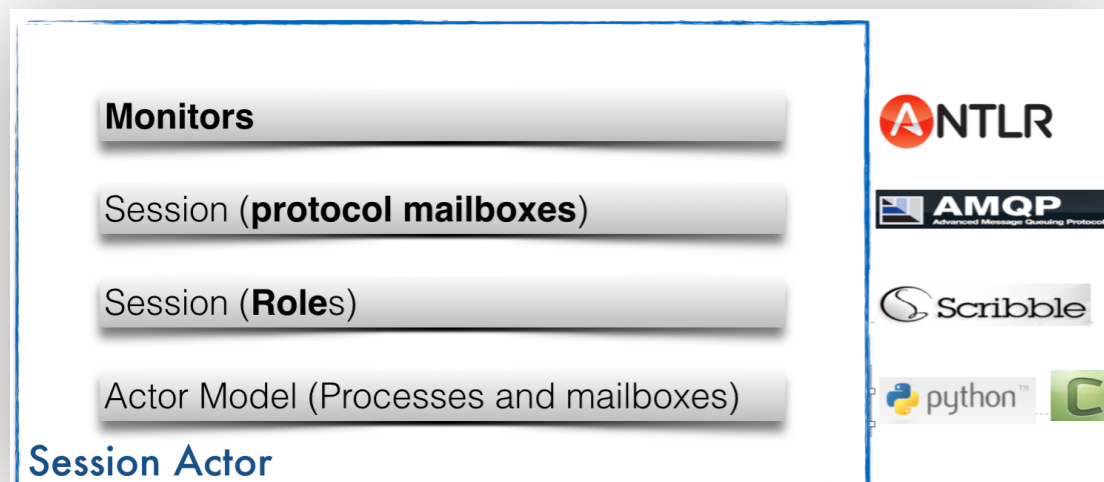

## MPI code generations

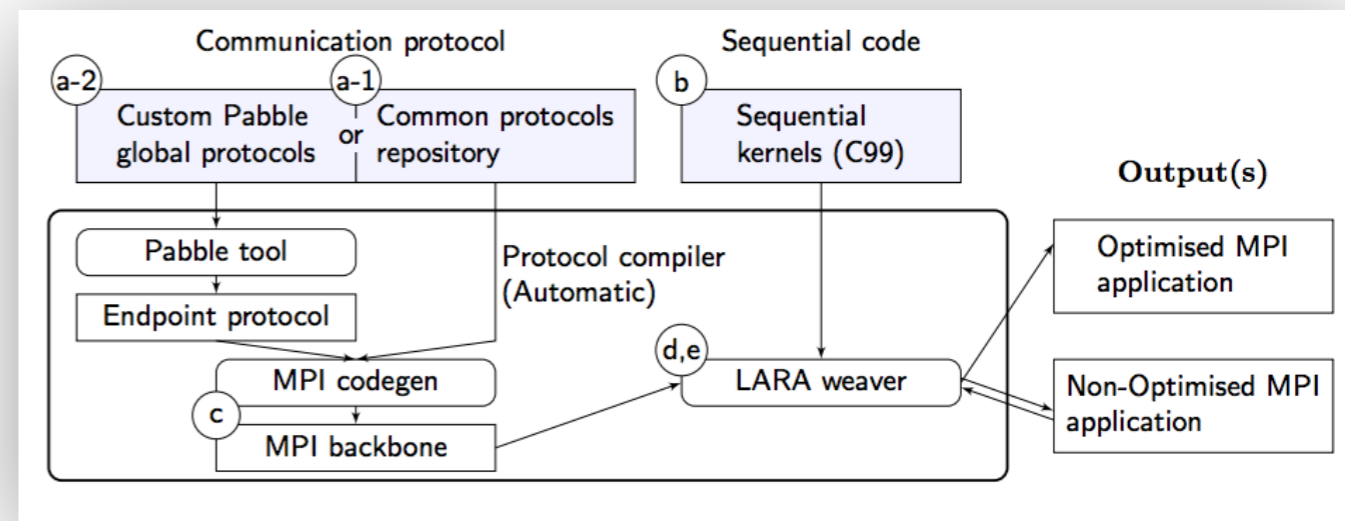

# Dynamic Monitoring

[RV'13, COORDINATION'14, FMSSD'15]

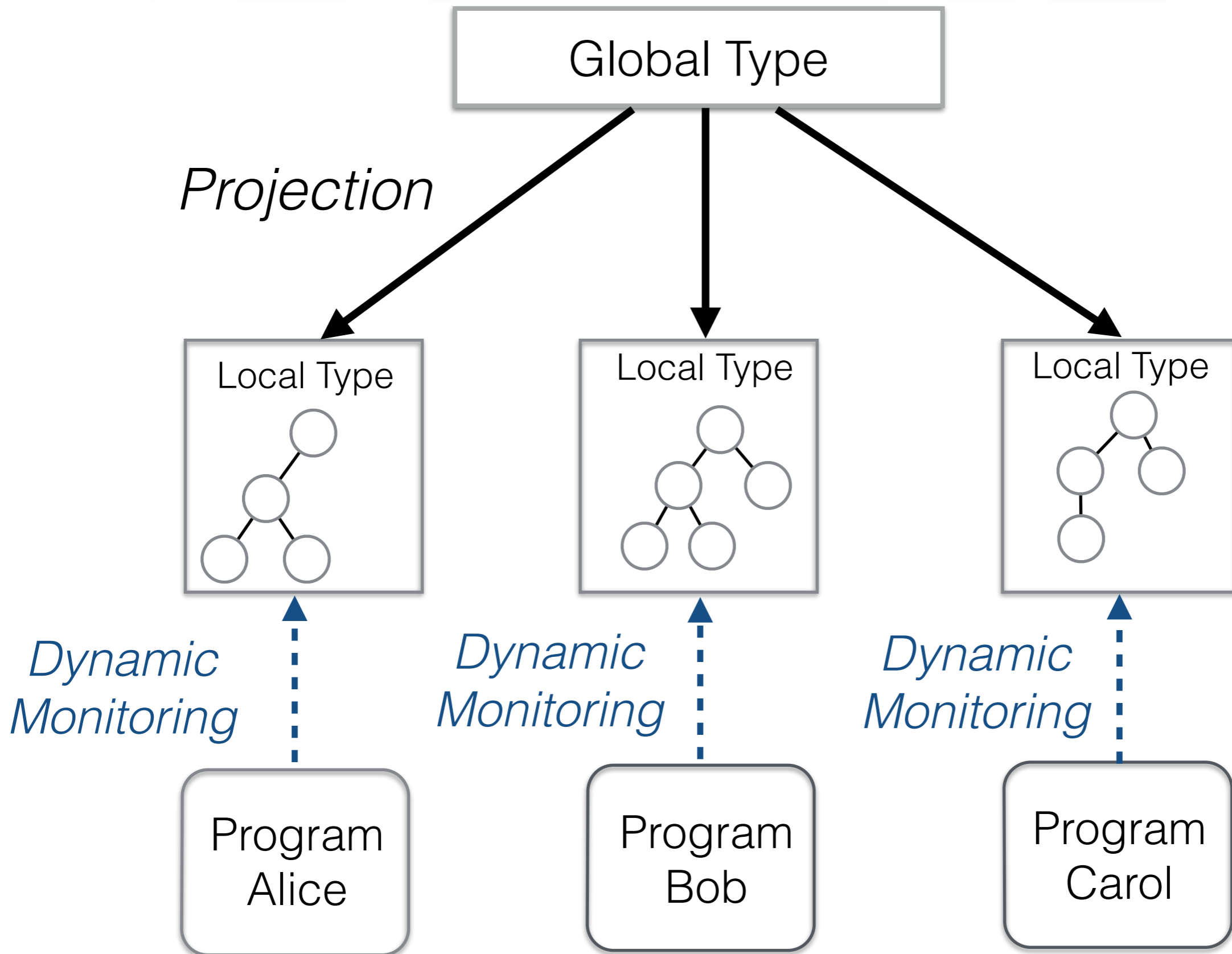

# Type Checking

[ECOOP'16, OOPSLA'15, POPL'16]

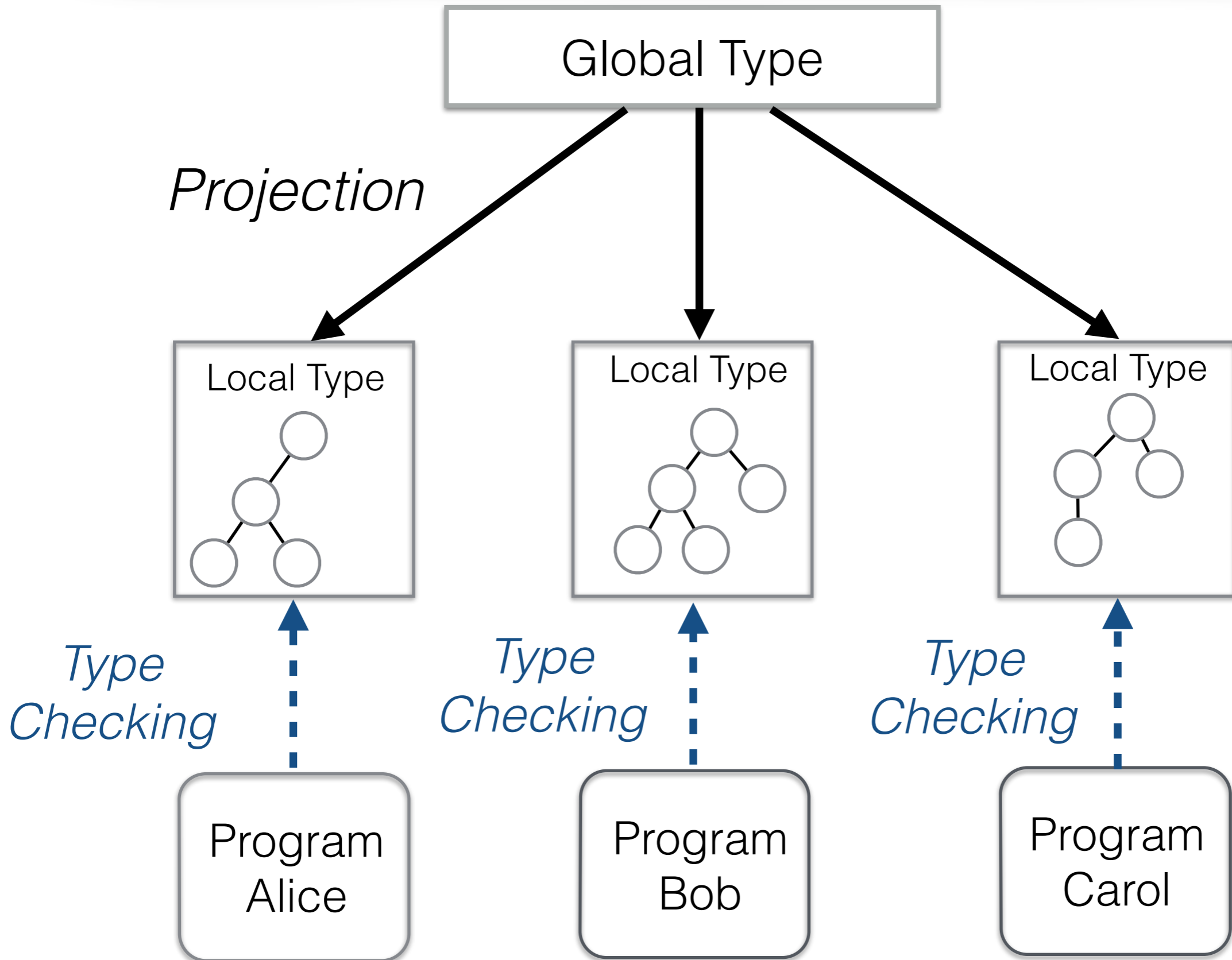

# Code Generation [CC'15, FASE'16]

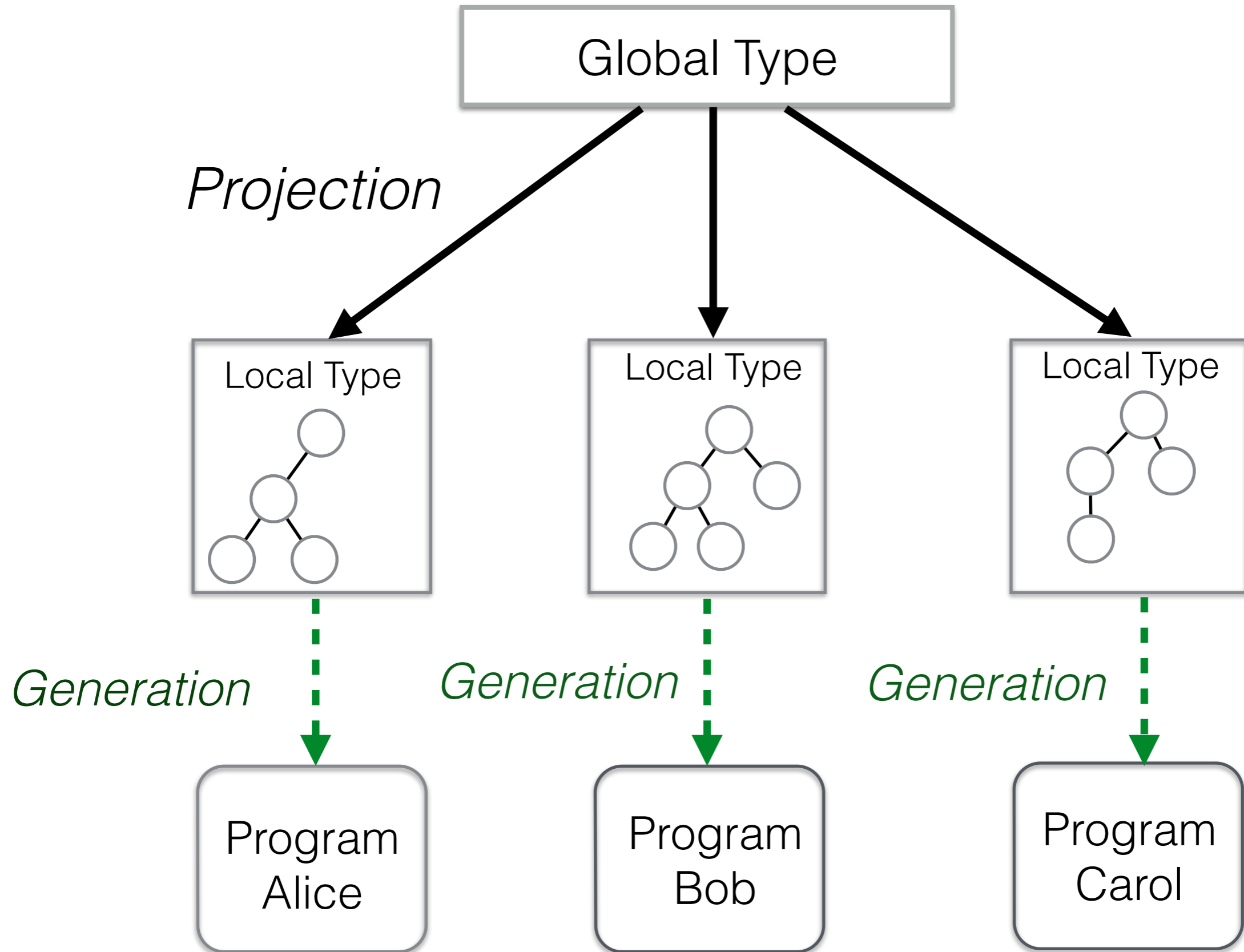

# Synthesis

[ICALP'13, POPL'15, CONCUR'15, TACAS'16, CC'16]

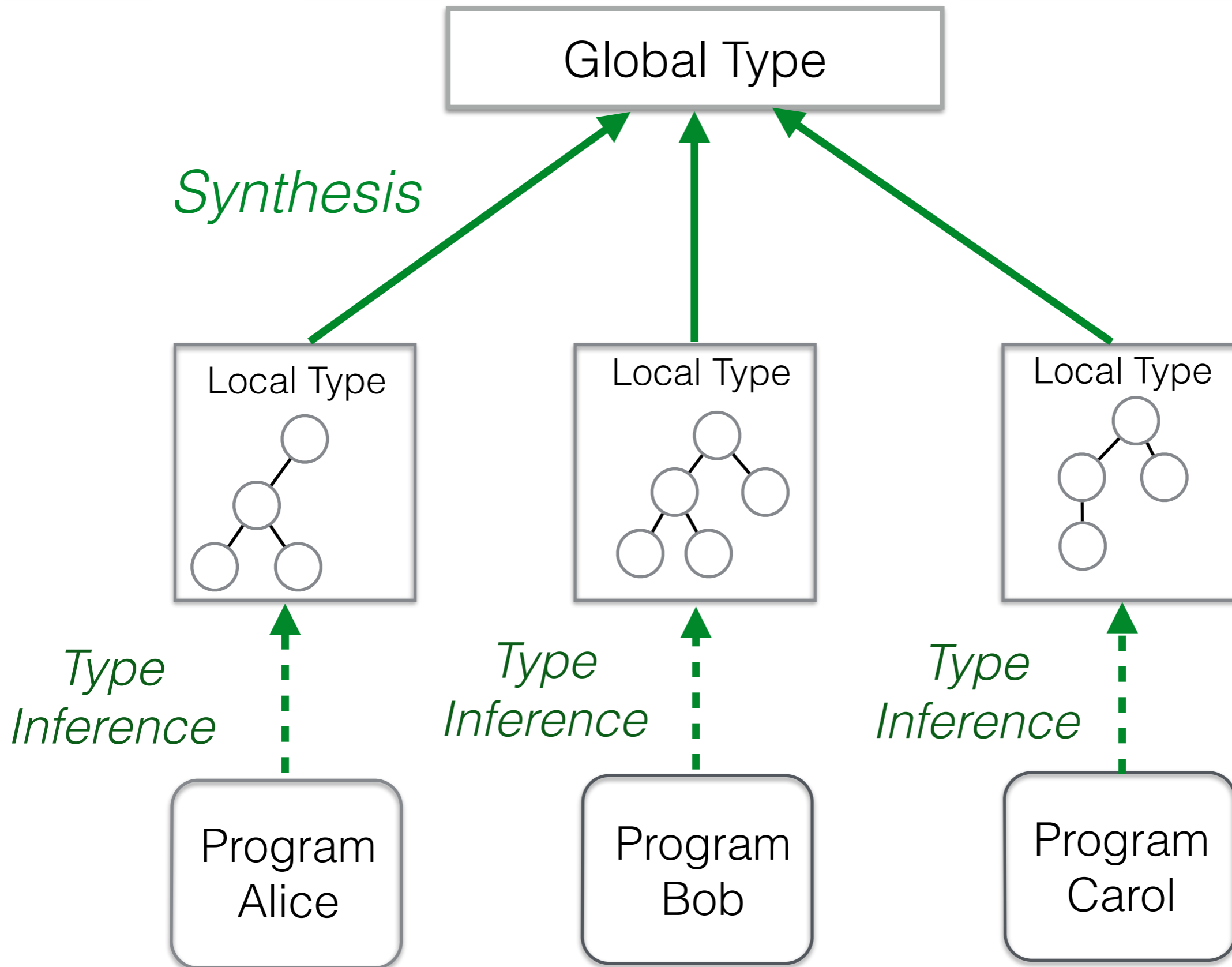

# Scribble SMTP

---

RFC 821

August 1982  
Simple Mail Transfer Protocol

## TABLE OF CONTENTS

<u>1.</u>	<u>INTRODUCTION</u>	<u>1</u>
<u>2.</u>	<u>THE SMTP MODEL</u>	<u>2</u>
<u>3.</u>	<u>THE SMTP PROCEDURE</u>	<u>4</u>
<u>3.1.</u>	<u>Mail</u>	<u>4</u>
<u>3.2.</u>	<u>Forwarding</u>	<u>7</u>
<u>3.3.</u>	<u>Verifying and Expanding</u>	<u>8</u>
<u>3.4.</u>	<u>Sending and Mailing</u>	<u>11</u>
<u>3.5.</u>	<u>Opening and Closing</u>	<u>13</u>
<u>3.6.</u>	<u>Relaying</u>	<u>14</u>
<u>3.7.</u>	<u>Domains</u>	<u>17</u>
<u>3.8.</u>	<u>Changing Roles</u>	<u>18</u>
<u>4.</u>	<u>THE SMTP SPECIFICATIONS</u>	<u>19</u>
<u>4.1.</u>	<u>SMTP Commands</u>	<u>19</u>
<u>4.1.1.</u>	<u>Command Semantics</u>	<u>19</u>
<u>4.1.2.</u>	<u>Command Syntax</u>	<u>27</u>
<u>4.2.</u>	<u>SMTP Replies</u>	<u>34</u>
<u>4.2.1.</u>	<u>Reply Codes by Function Group</u>	<u>35</u>
<u>4.2.2.</u>	<u>Reply Codes in Numeric Order</u>	<u>36</u>
<u>4.3.</u>	<u>Sequencing of Commands and Replies</u>	<u>37</u>
<u>4.4.</u>	<u>State Diagrams</u>	<u>39</u>
<u>4.5.</u>	<u>Details</u>	<u>41</u>
<u>4.5.1.</u>	<u>Minimum Implementation</u>	<u>41</u>
<u>4.5.2.</u>	<u>Transparency</u>	<u>41</u>
<u>4.5.3.</u>	<u>Sizes</u>	<u>42</u>
APPENDIX A:	TCP	44
APPENDIX B:	NCP	45
APPENDIX C:	NITS	46
APPENDIX D:	X.25	47
APPENDIX E:	Theory of Reply Codes	48
APPENDIX F:	Scenarios	51
	GLOSSARY	64
	REFERENCES	67



# Multiparty Compatibility in Communicating Automata

## Synthesis and Characterisation of Multiparty Session Types

Nobuko Yoshida

Pierre-Malo Denielóu **ICALP'13**

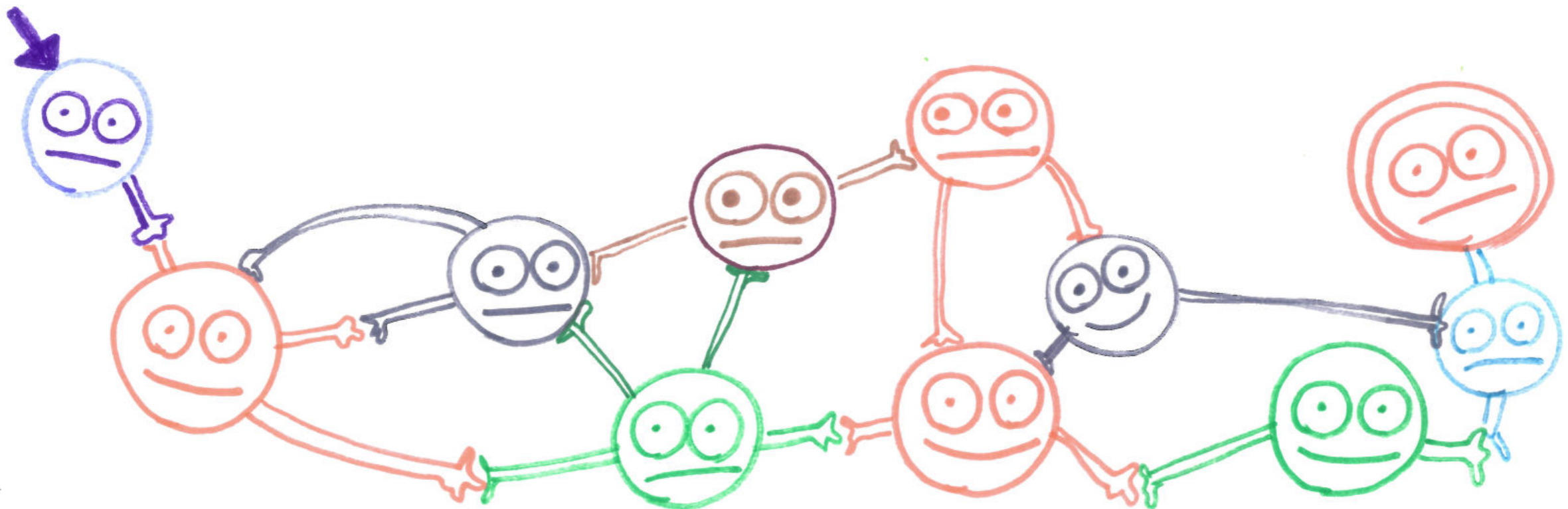

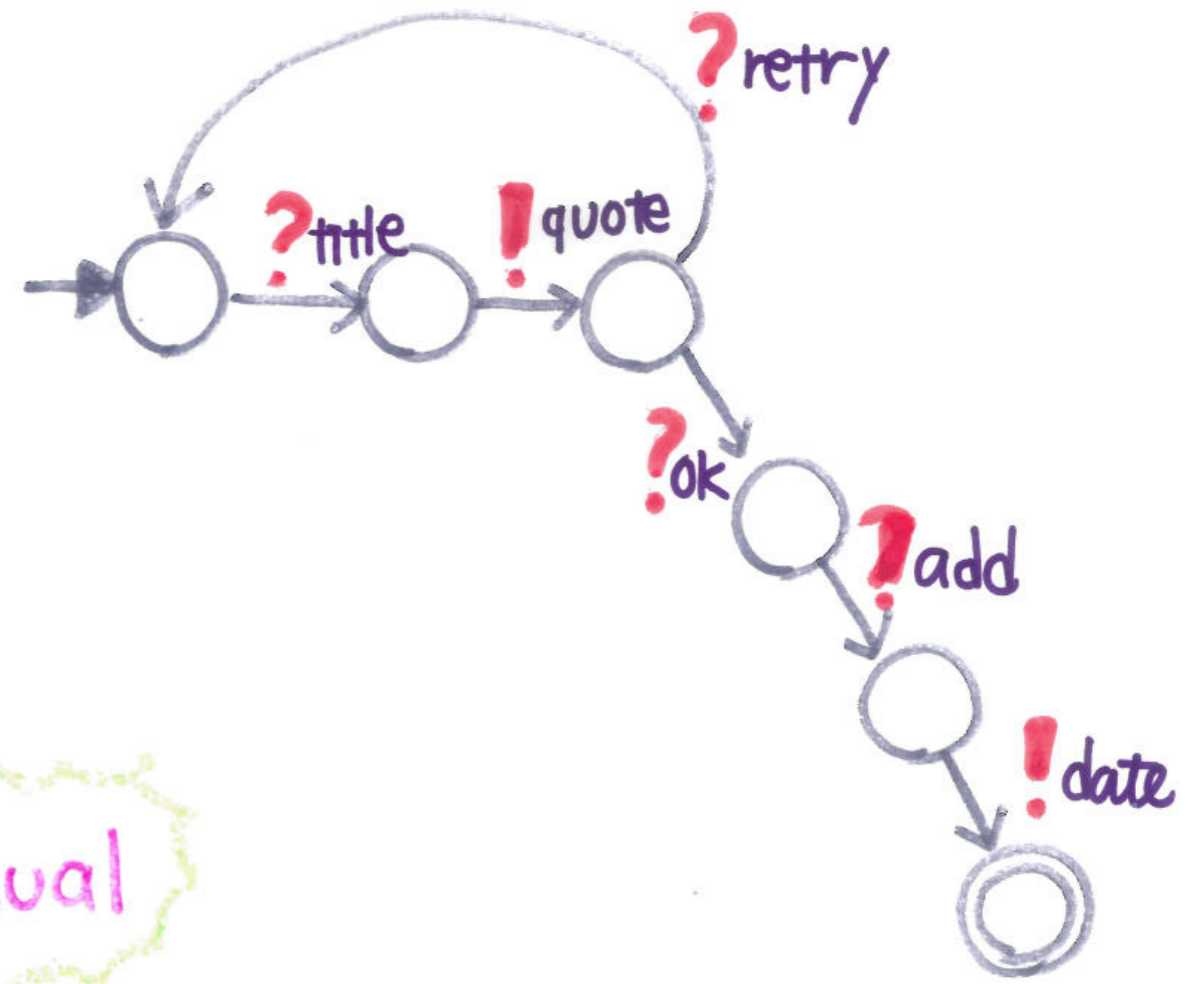
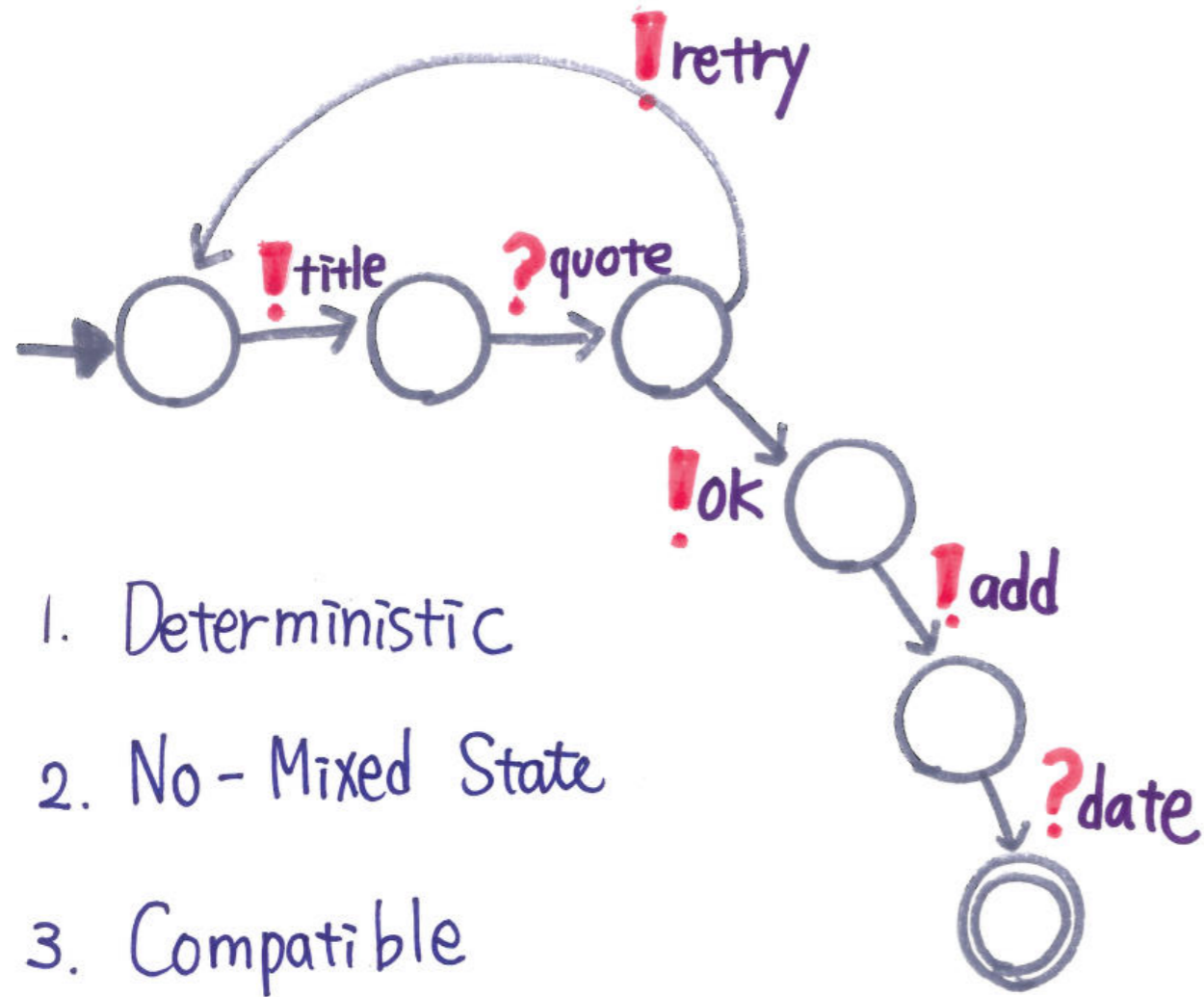

dual

[Gouda et al 1986] Two compatible machines without mixed states which are deterministic satisfy deadlock-freedom.

<http://www.zdlc.co/faq/>



[Home](#) [ZDLC Solutions](#) [FAQ](#) [Resources](#) [Events](#) [Blog](#) [Contact](#) [Partners](#) [Cognizant](#)



# Zero Deviation Life Cycle Platform

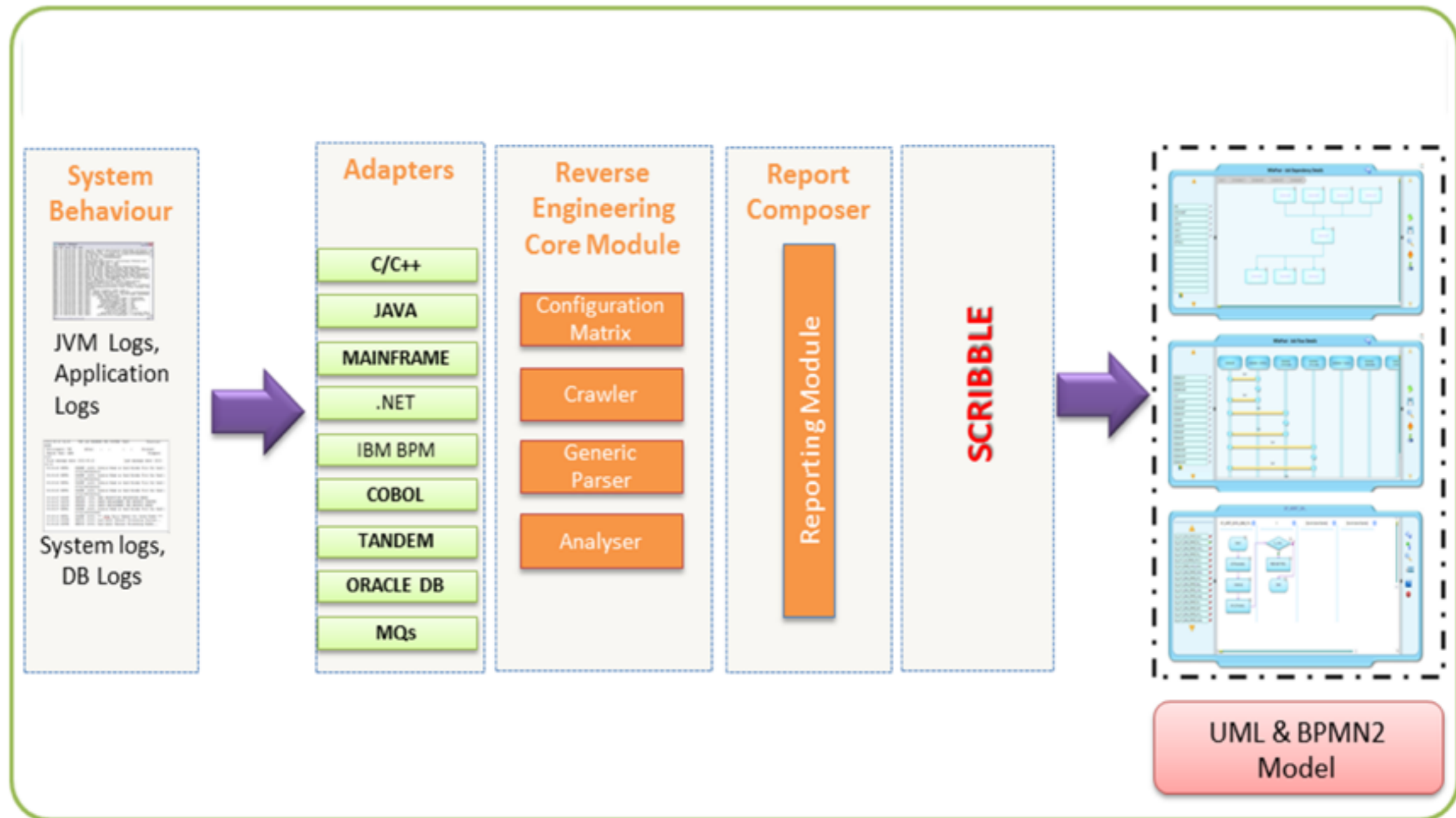

# From Communicating Machines to Graphical Choreographies [POPL'15, CONCUR'15]

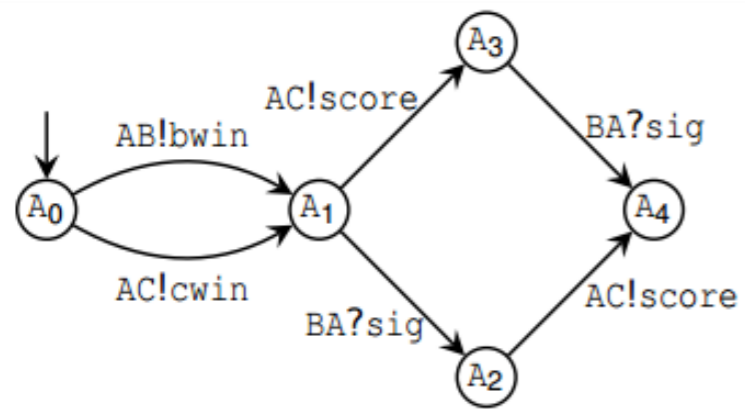

Alice

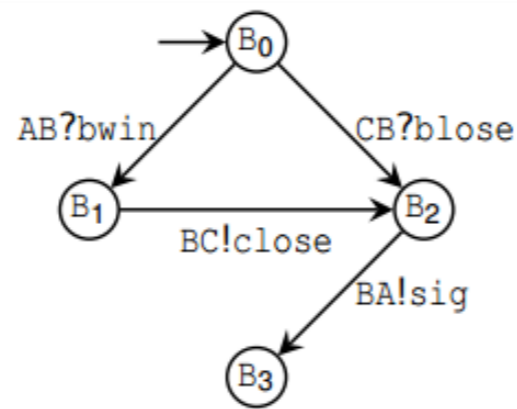

Bob

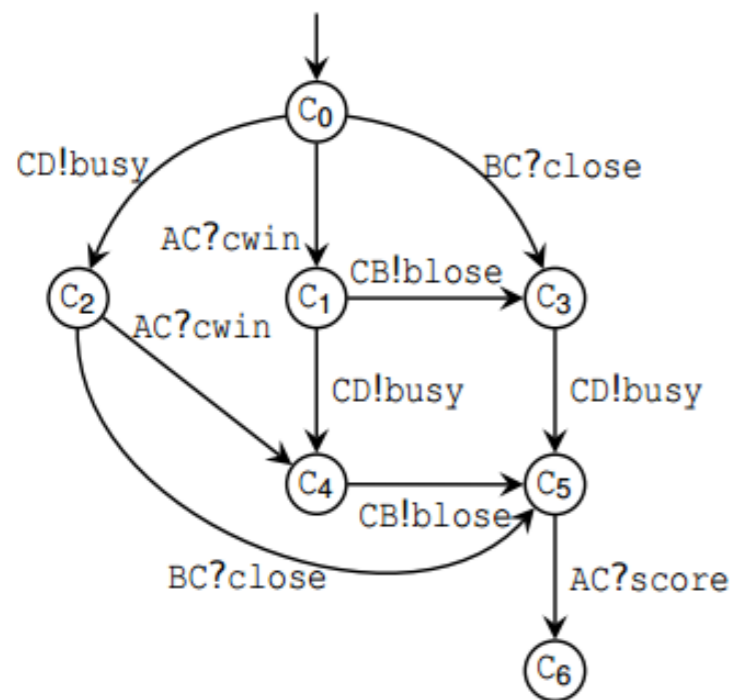

Carol

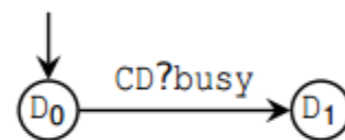

Dave

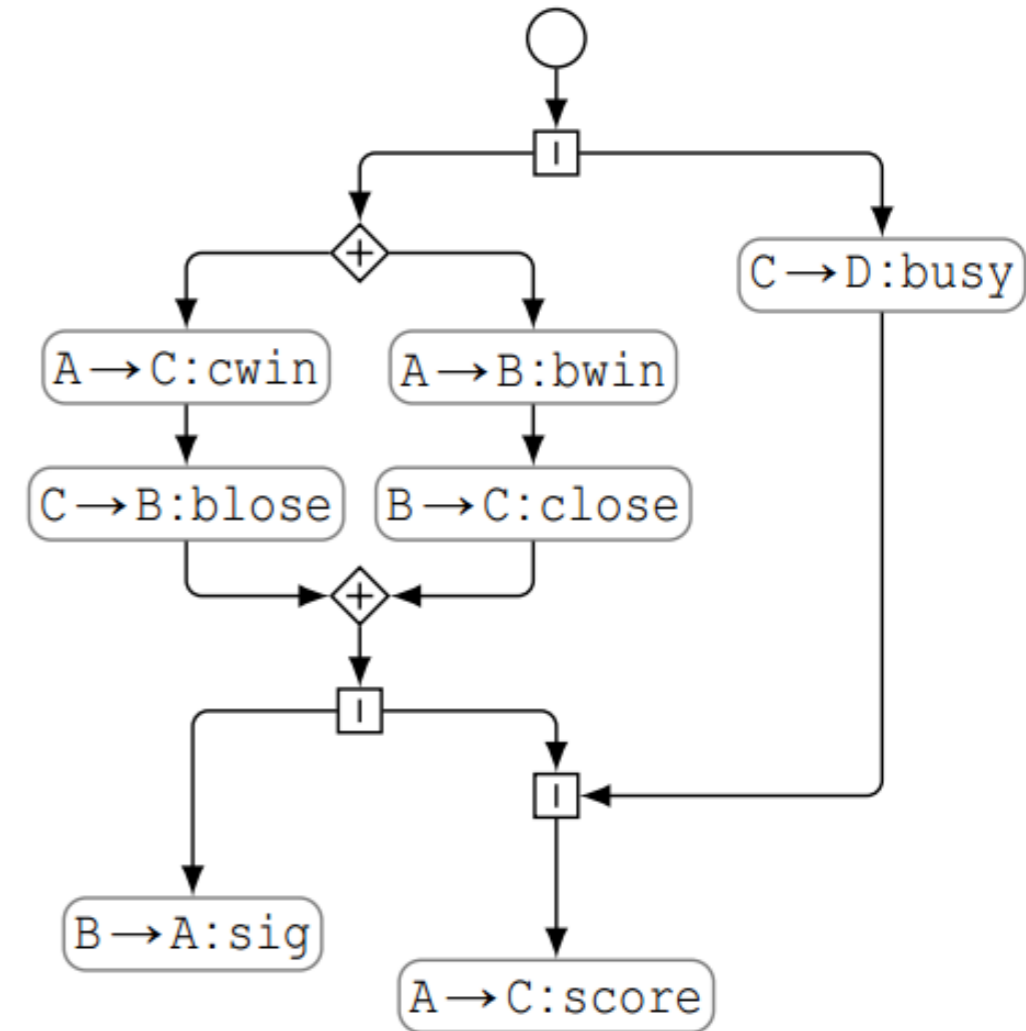

[ESOP'10, ESOP'12, CONCUR'12, CONCUR'14]

# Contributions

- Static deadlock detection tool *dingo-hunter*
- Deadlock detection based on session types
- **Infer** session types as Communicating Automata
- **Synthesise** global session graphs from CA

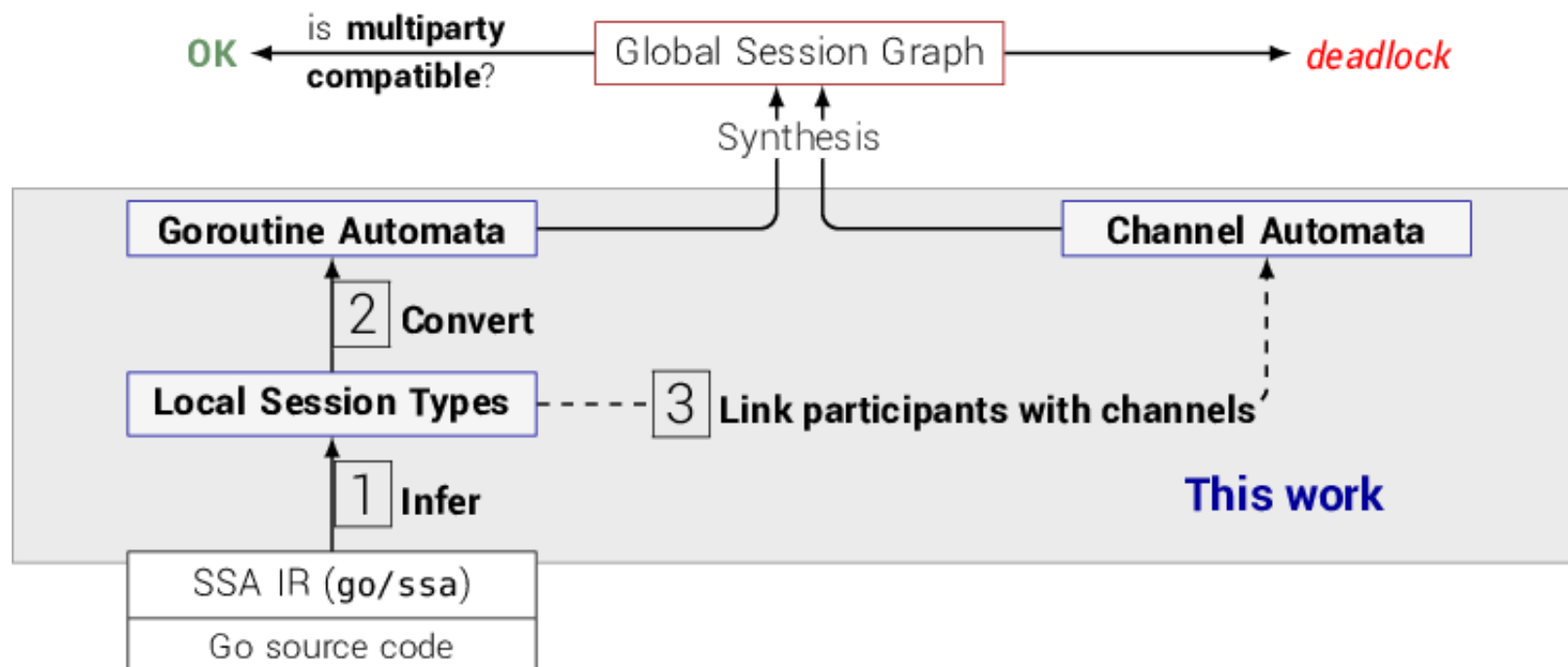

# Go and Concurrency

- Developed by Google for multi-core programming
- Concurrency model built on CSP (process calculi)
- Message-passing **communication** over channels

*" Do not communicate by sharing memory; instead, share memory by communicating. "*

-- Effective Go (developer guide)

# Session Type Mobility Group

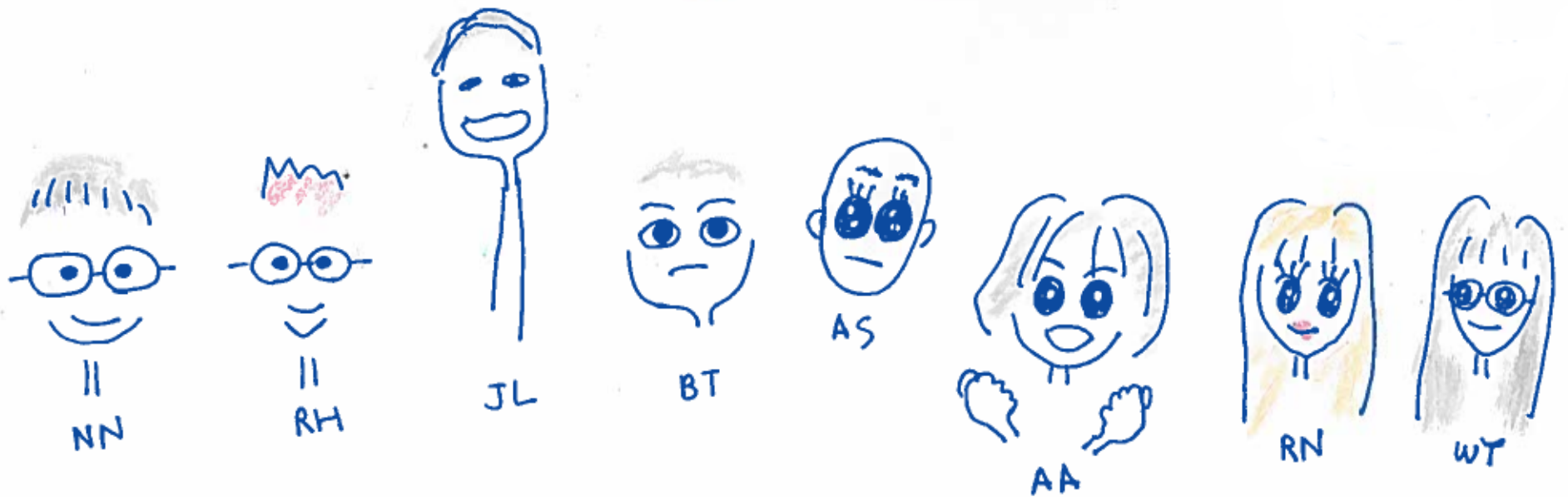

[www.mrg.doc.ic.ac.uk](http://www.mrg.doc.ic.ac.uk)